

| Modell: | | | ONE | ONE+ | PRO |
|---|-------------------|------|-------------------------------|---------------|----------------|
| Stromversorgung | V/Ph/ Hz | | 220~240/1/50 | 380~415/3/50 | 380~415/3/50 |
| Nennheizung (Max) (A7/6°C,W30/35°C) | Heizung Kapazität | kW | 3,0 ~ 9,1 | 5,5~15,1 | 7,5~22,1 |
| | Leistung Eingang | kW | 0,65~2,29 | 1,08~3,9 | 1,5~6,8 |
| | Aktuell Eingang | A | 2,8~9,1 | 1,8~6,9 | 2,7~12,3 |
| Nennheizung (Max) (A7/6°C,W47/55°C) | Heizung Kapazität | kW | 2,85~8,50 | 5,0~13 | 7,0 ~ 18,9 |
| | Leistung Eingang | kW | 0,95~2,85 | 1,75~4,96 | 2,15~7,35 |
| | Aktuell Eingang | A | 2,9 ~ 9,2 | 1,9~7,0 | 2,8~12,4 |
| Nennkühlung (Max) (A35/24°C,W12/7°C) | Kühlung Kapazität | kW | 1,25~5,8 | 3,65~10,2 | 4,5~17,7 |
| | Leistung Eingang | kW | 0,65~2,35 | 1.12~4.16 | 1,80~7,30 |
| | Aktuell Eingang | A | 2,9 ~ 10,4 | 2,0 ~ 7,8 | 3,3 ~ 12,9 |
| ERP-Ebene(Auslasswassertemp. bei 35°C) | | / | A+++ | A+++ | A+++ |
| MAX. Eingangsleistung | | kW | 3,00 | 5,50 | 9.00 |
| MAX. Eingangsstrom | | A | 13.50 | 10.50 | 16.00 |
| Kältemittel / Gewicht | | / | R290 | R290 | R290 |
| Nennwasserdurchfluss | | m3/h | 1,00 | 1,80 | 3,00 |
| Lüftermenge | | / | 1 | 1 | 2 |
| Lüftermotortyp | | / | DC-Wechselrichter | | |
| Kompressor | | / | DC-Wechselrichter | | |
| Umwälzpumpe | | / | Wechselrichtertyp / Eingebaut | | |
| IP-Klasse | / | | IPX4 | | |
| Schalldruck in 1m Entfernung | dB(A) | | 42 | 44 | 48 |
| Maximale Wasseraustrittstemperatur | °C | | 75 | 75 | 75 |
| Anschlüsse für Wasserleitungen | / | | DN 25 (1") | DN 25 (1") | DN 32 (1-1/4") |
| Wasserdruckabfall (max.) | kPa | | 20 | 25 | 60 |
| Betriebstemperaturbereich (Heizmodus) | °C | | - 30~45 | | |
| Betriebstemperaturbereich (Gurrmodus) | °C | | 16~45 | | |
| Ausgepackte Abmessungen (L×T×H) | mm | | 1187*418*805 | 1287*448*904 | 1187*488*1455 |
| Packmaße (L×T×H) | mm | | 1217*463*920 | 1317*493*1020 | 1217*538*1570 |
| Ausgepacktes Gewicht | kg | | 90 | 110 | 145 |
| Packgewicht | kg | | 115 | 125 | 160 |

#290



ONE
ONE+
PRO

Air Source Heat Pump

Heat Pump for Heating & Cooling & DHW

Please read this manual carefully before using it and keep it in a safe place.

Note

1. Please read the instruction manual carefully before installation or operation.
2. The heat pump must be installed by a professional installer.
3. Please follow the instruction manual strictly when installing the heat pump
4. If any update on the product, this instruction manual is subject to change without notice
5. If the heat pump is installed where is vulnerable to lightning strikes, it is necessary to take lightning protection measures; if the heat pump is turned off in the winter, please be sure to drain the water in the system to prevent cold water from swelling and causing system damage.

Contents

| | |
|--------------------------------------|----|
| User Instruction | 1 |
| Operation Instructions | 12 |
| Dimension | 19 |
| Installation | 23 |
| Commissioning and Maintenance | 34 |
| Trouble Analysis | 36 |
| Specification | 39 |
| After-sale service | 41 |
| Appendix | 42 |

User Instructions

1. Please use an electrical leakage switch, otherwise, there may be electric shock, fire, etc.

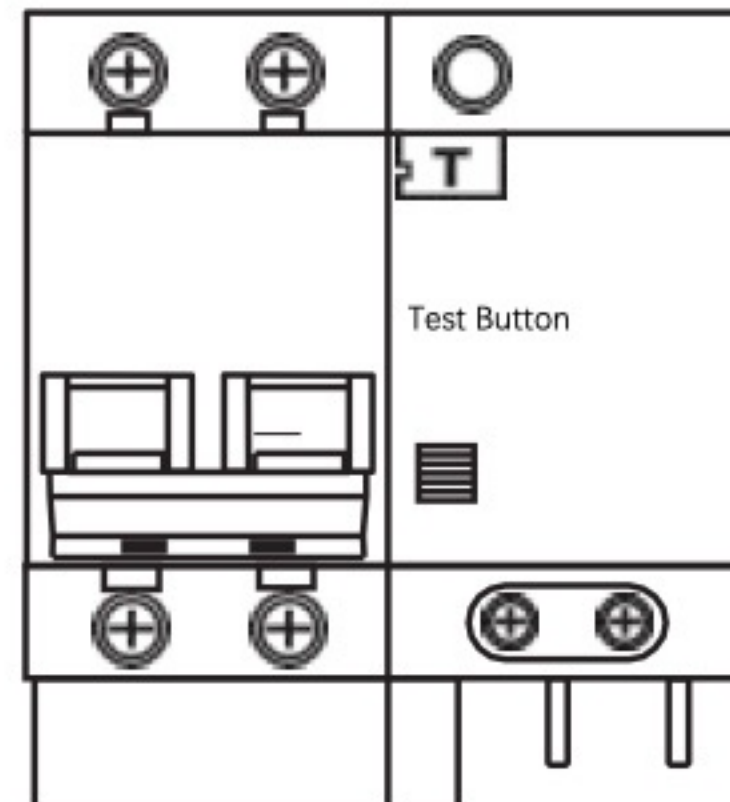

2. Make sure that the leakage protection switch is securely connected. If the wiring is not secure, it may cause electric shock, heat, or fire.

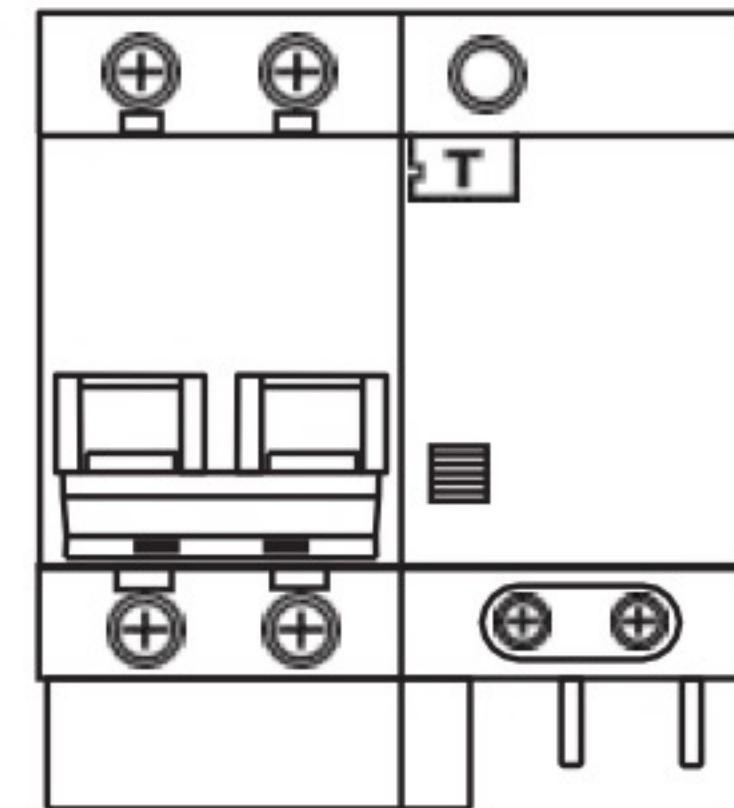

3. Do not operate with a wet hand, otherwise, there may cause electric shock.

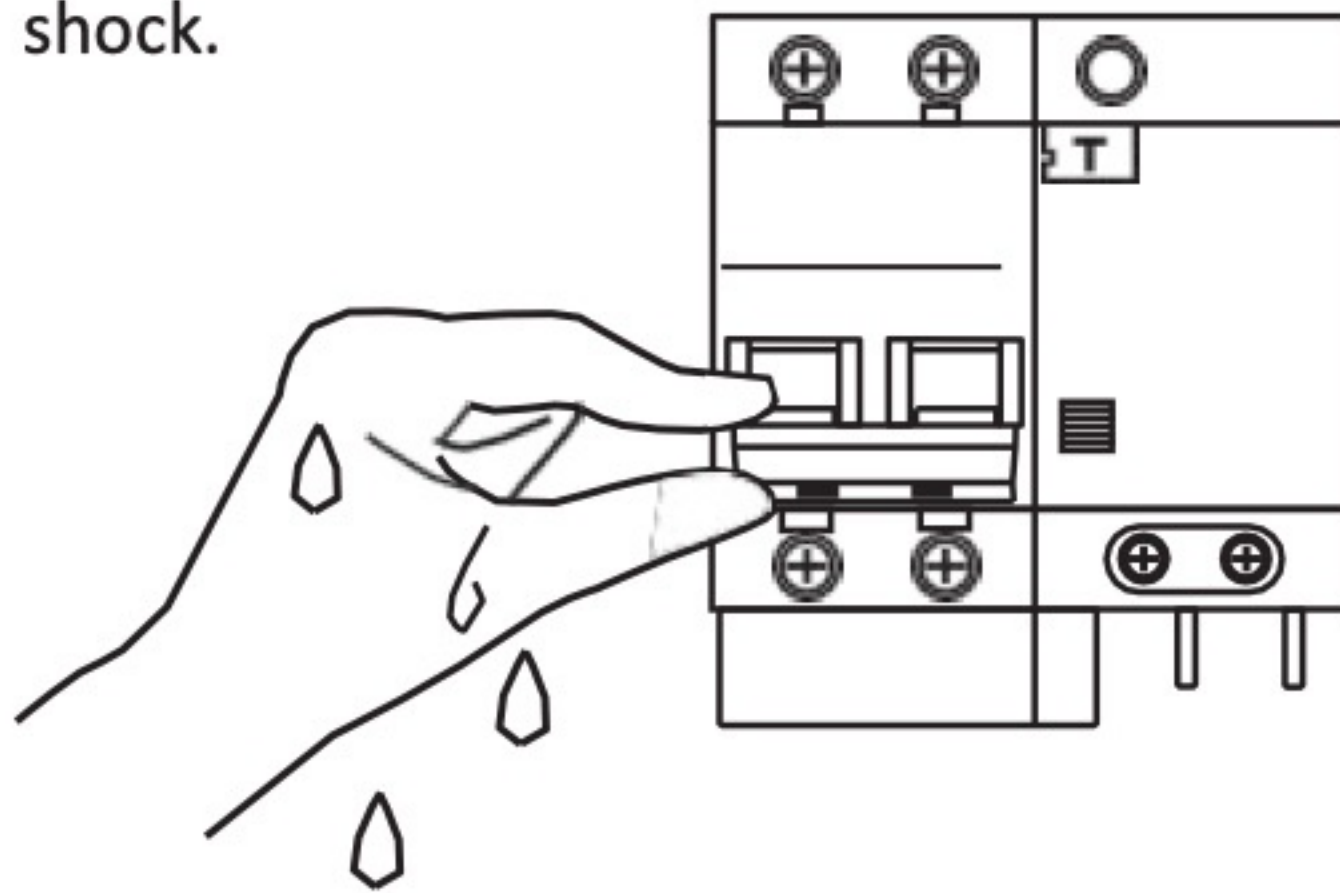

4. Do not insert your fingers or any stick into the inside of the ventilation area, otherwise, harm will be caused.

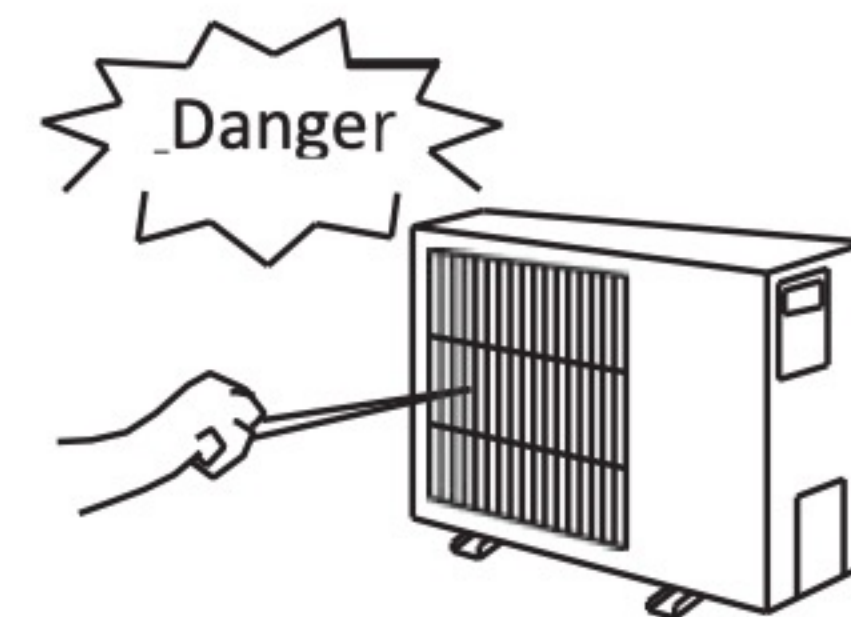

R290 Warning



RISK OF FIRE

- **This appliance uses R290 (propane) refrigerant, which is a flammable gas and must be serviced by an authorized person.**
- **WARNING Risk of fire/flammable material. If the refrigerant is leaking, switch off the unit at the mains and contact the service agent.**
- **DO NOT store chemicals or flammable materials near this appliance.**
- **NEVER use a flammable spray such as hair spray, paint, etc near this unit as this may cause a fire.**
- **Avoid risk of injury from contact with refrigerant if you notice a leak.**
- **If you suspect the refrigerant is leaking then:**
- **Do not smoke.**
- **Do not operate electrical equipment. Isolate the device.**
- **End of life recycling**
The refrigerant must not enter the atmosphere. Only have the refrigerant removed by qualified professional.

1. Precautions

Please make sure that you have read this manual before using our air source heat pump. In the “User Information” chapter, “User Information” provides essential safety information. Please be sure to follow the instruction strictly.



Warning

Wrong operations are likely to cause serious consequences such as death, serious injury, or major accidents



Note

Improper operation may result in a safety accident, damage to the machine, or affect the function of the machine.

Please read the labels on the machine carefully. If abnormal conditions such as abnormal noise, odor, smoke, temperature rise, electric leakage, fire, etc. are found during use, please cut off the power immediately and contact our local customer service center or dealer in time to repair it. Contact the local fire and emergency department immediately if necessary.



Warning

- 1) This Machine is not allowed to be installed by the user. A professional installer must install it, Otherwise cause safety accidents or affects the machine’s performance.
- 2) Without professional guidance, non-professionals are not allowed to disassemble the machine. Otherwise, accidents or damage may be caused to the device.
- 3) Do not use or store flammable materials such as hair spray, paint, gasoline, alcohol, etc., around the machine. Otherwise, fire may be caused.
- 4) The machine’s main power switch should be placed where that child cannot reach to prevent children from playing with the power switch.
- 5) Do not spray water or other liquids on the machine. Otherwise, danger may occur.
- 6) Do not touch the machine with wet hands. Otherwise, it may cause an electric shock.
- 7) In thunderstorms, please disconnect the main power switch off the machine. Otherwise, lightning may cause danger or damage to the device.
- 8) The machine needs to use a separate power switch to avoid sharing the same circuit with other electrical appliances, supply the power to the machine vice the specified power cable, and use the proper breaker with the electric leakage protection required.
- 9) The machine must be installed with a specified grounding wire. Do not connect the grounding wire to the gas pipe, water pipe, lightning conductor, or telephone, and the machine must be grounded reliably to avoid any electric shock.
- 10) Do not disconnect the power supply when the machine is running.
- 11) When the machine is not used for a long time, please disconnect the main power switch to avoid accidents.
- 12) If the ambient temperature is below 0 °C , it is forbidden to cut off the power supply. If the power is turned off unexpectedly under these conditions, drain the water inside the pipeline.



Note

-
- 1) Do not put your hands or other objects into the air outlet of the machine. Otherwise, the fan running at high speed may cause harm.
 - 2) Do not remove the fan cover. Otherwise, the fan running at high speed may cause injury to you or others.
 - 3) Lightning and other sources of electromagnetic radiation may have a remarkable effect on the machine. Turn off the power and then restart the device if it does affect it.
 - 4) Make sure the water supply is frequent. Otherwise, the machine may be damaged.
 - 5) Do not restart the machine frequently. Otherwise, the device may be damaged.
 - 6) The operating parameters of the machine and the set value of the protection device have been selected by the manufacturer. Users should not change the set value arbitrarily and do not short the wire of the protection device. Otherwise, the machine may be damaged due to improper protection.
 - 7) To avoid the freezing of the water system pipeline when the machine is deactivated in an environment below 0 °C, please keep the machine standby state. If the device is out of service for a long time, it is recommended that the user drain the water out of the water system and disconnect the power supply.
 - 8) Please perform regular maintenance on the machine as required by the instructions to ensure the device is in good operating condition.

2. Refrigerant Precaution

- 1) Do not use means to accelerate the defrosting process or to clean, other than those recommended by the manufacturer.
- 2) The appliance shall be stored in a room without continuously operating ignition sources (for example open flames, an operating gas appliance, or an operating electric heater)
- 3) Do not pierce or burn.
- 4) Be aware that refrigerants may not contain an odor.
- 5) Appliance shall be installed, operated, and stored in a room with a floor area larger than X m²
- 6) The installation of pipe-work shall be kept to a minimum of X m²
- 7) Spaces where refrigerant pipes shall be in compliance with national gas regulations.
- 8) Servicing shall be performed only as recommended by the manufacturer.
- 9) The appliance shall be stored in a well-ventilated area where the room size corresponds to the room area as specified for operation.
- 10) All working procedures that affect safety means shall only be carried out by competent persons.

3. Requirement of Flammable Refrigerant

- 1) Transport of equipment containing flammable refrigerants: Compliance with the transport regulations
- 2) Marking of equipment using signs: Compliance with local regulations
- 3) Disposal of equipment using flammable refrigerants: Compliance with national regulations
- 4) Storage of equipment/appliances: The storage of equipment should be in accordance with the manufacturer's instructions.
- 5) Storage of packed (unsold) equipment: Storage package protection should be constructed such that mechanical damage to the equipment inside the package will not cause a leak of the refrigerant charge. The maximum number of pieces of equipment permitted to be stored together will be determined by local regulations.
- 6) Information on servicing:

-
- i. Checks to the area
Prior to beginning work on systems containing flammable refrigerants, safety checks are necessary to ensure that the risk of ignition is minimized. For repair to the refrigerating system, the following precautions shall be complied with prior to conducting work on the system.
 - ii. Work Procedure
Work shall be undertaken under a controlled procedure so as to minimize the risk of flammable gas or vapor being present while the work is being performed.
 - iii. General Work Area
All maintenance staff and others working in the local area shall be instructed on the nature of the work being carried out. Work in confined spaces shall be avoided. The area around the workspace shall be sectioned off. Ensure that the conditions within the area have been made safe by control of flammable material.
 - iv. Checking for the presence of refrigerant
The area shall be checked with an appropriate refrigerant detector prior to and during work, to ensure the technician is aware of potentially flammable atmospheres. Ensure that the leak detection equipment being used is suitable for use with flammable refrigerants, i.e. non-sparking, adequately sealed or intrinsically safe.
 - v. Presence of fire extinguisher
If any hot work is to be conducted on the refrigeration equipment or any associated parts, appropriate fire extinguishing equipment shall be available to hand. Have a dry powder or CO2 fire extinguisher adjacent to the charging area.
 - vi. No ignition sources
No person carrying out work in relation to a refrigeration system that involves exposing any pipework that contains or has contained flammable refrigerant shall use any sources of ignition in such a manner that it may lead to the risk of fire or explosion. All possible ignition sources, including cigarette smoking, should be kept sufficiently far away from the site of installation, repairing, removal, and disposal, during which flammable refrigerant can possibly be released to the surrounding space. Prior to work taking place, the area around the equipment is to be surveyed to make sure that there are no flammable hazards or ignition risks. "No Smoking" signs shall be displayed.
 - vii. Ventilated area
Ensure that the area is in the open or that it is adequately ventilated before breaking into the system or conducting any hot work. A degree of ventilation shall continue during the period that the work is carried out. The ventilation should safely disperse any released refrigerant and preferably expel it externally into the atmosphere.
 - viii. Checks to the refrigeration equipment
Where electrical components are being changed, they shall be fit for the purpose and to the correct specification. At all times the manufacturer's maintenance and service guidelines shall be followed. If in doubt consult the manufacturer's technical department for assistance. The following checks shall be applied to installations using flammable refrigerants:
 - The charge size is in accordance with the room size within which the refrigerant containing parts are installed;
 - The ventilation machinery and outlets are operating adequately and are not obstructed;
 - If an indirect refrigerating circuit is being used, the secondary circuit shall be checked for the presence of refrigerant;
 - Marking of the equipment continues to be visible and legible. Markings and signs that are illegible shall be corrected;
 - Refrigeration pipes or components are installed in a position where they are unlikely to be exposed to any substance which may corrode refrigerant-containing components unless the components are constructed of materials that are inherently resistant to being corroded or

are suitably protected against being so corroded.

ix. Checks to electrical devices

Repair and maintenance to electrical components shall include initial safety checks and component inspection procedures. If a fault exists that could compromise safety, then no electrical supply shall be connected to the circuit until it is satisfactorily dealt with. If the fault cannot be corrected immediately but it is necessary to continue operation, an adequate temporary solution shall be used. This shall be reported to the owner of the equipment so all parties are advised.

Initial safety checks shall include:

- That capacitor is discharged: this shall be done in a safe manner to avoid the possibility of sparking;
- That there no live electrical components and wiring are exposed while charging, recovering, or purging the system;
- That there is continuity of earth bonding.

7) Repairs sealed components:

a) During repairs to sealed components, all electrical supplies shall be disconnected from the equipment being worked upon prior to any removal of sealed covers, etc. If it is absolutely necessary to have an electrical supply to equipment during servicing, then a permanently operating form of leak detection shall be located at the most critical point to warn of a potentially hazardous situation.

b) Particular attention shall be paid to the following to ensure that by working on electrical components, the casing is not altered in such a way that the level of protection is affected. This shall include damage to cables, an excessive number of connections, terminals not made to original specification, damage to seals, incorrect fitting of glands, etc. Ensure that apparatus is mounted securely. Ensure that seals or sealing materials have not degraded such that they no longer serve the purpose of preventing the ingress of flammable atmospheres. Replacement parts shall be in accordance with the manufacturer's specifications.

NOTE: The use of silicone sealant may inhibit the effectiveness of some types of the leak.

8) Repair to intrinsically safe components

Do not apply any permanent inductive or capacitance loads to the circuit without ensuring that this will not exceed the permissible voltage and currently permitted for the equipment in use. Intrinsically safe components are the only types that can be worked on while living in the presence of a flammable atmosphere. The test apparatus shall be at the correct rating. Replace components only with parts specified by the manufacturer. Other parts may result in the ignition of refrigerant in the atmosphere from a leak.

9) Cabling

Check that cabling will not be subject to wear, corrosion, excessive pressure, vibration, sharp edges or any other adverse environmental effects. The check shall also take into account the effects of aging or continual vibration from sources such as compressors or fans.

10) Detection of flammable refrigerants

Under no circumstances shall potential sources of ignition be used in the searching for or detection of refrigerant leaks. A halide torch (or any other detector using a naked flame) shall not be used.

11) Leak detection methods

The following leak detection methods are deemed acceptable for systems containing flammable refrigerants.

Electronic leak detectors shall be used to detect flammable refrigerants, but the sensitivity may not be adequate or may need re-calibration. (Detection equipment shall be calibrated in a refrigerant-free area.) Ensure that the detector is not a potential source of ignition and is suitable for the refrigerant used. Leak detection equipment shall be set at a percentage of the

LFL of the refrigerant and shall be calibrated to the refrigerant employed and the appropriate percentage of gas (25 % maximum) is confirmed.

Leak detection fluids are suitable for use with most refrigerants but the use of detergents containing chlorine shall be avoided as the chlorine may react with the refrigerant and corrode the copper pipe-work.

12) Removal and evacuation

When breaking into the refrigerant circuit to make repairs – or for any other purpose – conventional procedures shall be used. However, it is important that best practice is followed since flammability is a consideration. The following procedure shall be adhered to:

- Remove refrigerant;
- Purge the circuit with inert gas;
- Evacuate;
- Purge again with inert gas;
- Open the circuit by cutting or brazing.

The refrigerant charge shall be recovered into the correct recovery cylinders. The system shall be “flushed” with OFN to render the unit safe. This process may need to be repeated several times. Compressed air or oxygen shall not be used for this task.

Flushing shall be achieved by breaking the vacuum in the system with OFN and continuing to fill until the working pressure is achieved, then venting to the atmosphere, and finally pulling down to a vacuum. This process shall be repeated until no refrigerant is within the system. When the final OFN charge is used, the system shall be vented down to atmospheric pressure to enable work to take place. This operation is absolutely vital if brazing operations on the pipe-work are to take place.

Ensure that the outlet for the vacuum pump is not close to any ignition sources and there is ventilation available.

13) Charging procedures

In addition to conventional charging procedures, the following requirements shall be followed.

--Ensure that contamination of different refrigerants does not occur when using charging equipment. Hoses or lines shall be as short as possible to minimize the amount of refrigerant contained in them.

--Cylinders shall be kept upright.

--Ensure that the refrigeration system is earthed prior to charging the system with refrigerant.

--Label the system when charging is complete (if not already).

--Extreme care shall be taken not to overfill the refrigeration system.

--Prior to recharging the system, it shall be pressure tested with OFN. The system shall be leak tested on completion of charging prior to commissioning. A follow-up leak test shall be carried out prior to leaving the site.

14) Decommissioning

Before carrying out this procedure, it is essential that the technician is completely familiar with the equipment and all its detail. It is recommended good practice that all refrigerants are recovered safely. Prior to the task being carried out, an oil and refrigerant sample shall be taken in case analysis is required prior to re-use of reclaimed refrigerant. It is essential that electrical power is available before the task is commenced.

a) Become familiar with the equipment and its operation.

b) Isolate system electrically.

c) Before attempting the procedure ensure that:

- Mechanical handling equipment is available, if required, for handling refrigerant cylinders;
- All personal protective equipment is available and being used correctly;
- The recovery process is supervised at all times by a competent person;
- Recovery equipment and cylinders conform to the appropriate standards.

-
- d) Pump down refrigerant system, if possible.
 - e) If a vacuum is not possible, make a manifold so that refrigerant can be removed from various parts of the system.
 - f) Make sure that cylinder is situated on the scales before recovery takes place.
 - g) Start the recovery machine and operate in accordance with manufacturer's instructions.
 - h) Do not overfill cylinders. (No more than 80 % volume liquid charge).
 - i) Do not exceed the maximum working pressure of the cylinder, even temporarily.
 - j) When the cylinders have been filled correctly and the process completed, make sure that the cylinders and the equipment are removed from the site promptly and all isolation valves on the equipment are closed off.
 - k) Recovered refrigerant shall not be charged into another refrigeration system unless it has been cleaned and checked.
- 15) Labelling
- Equipment shall be labeled stating that it has been decommissioned and emptied of refrigerant. The label shall be dated and signed. Ensure that there are labels on the equipment stating the equipment contains flammable refrigerant.
- 16) Recovery
- When removing refrigerants from a system, either for servicing or decommissioning, it is recommended good practice that all refrigerants are removed safely. When transferring refrigerant into cylinders, ensure that only appropriate refrigerant recovery cylinders are employed. Ensure that the correct number of cylinders for holding the total system charge is available. All cylinders to be used are designated for the recovered refrigerant and labeled for that refrigerant (i.e. special cylinders for the recovery of refrigerant). Cylinders shall be complete with a pressure relief valve and associated shut-off valves in good working order. Empty recovery cylinders are evacuated and, if possible, cooled before recovery occurs. The recovery equipment shall be in good working order with a set of instructions concerning the equipment that is at hand and shall be suitable for the recovery of flammable refrigerants. In addition, a set of calibrated weighing scales shall be available and in good working order. Hoses shall be complete with leak-free disconnect couplings and in good condition. Before using the recovery machine, check that it is in satisfactory working order, has been properly maintained, and that any associated electrical components are sealed to prevent ignition in the event of a refrigerant release. Consulting manufacturer if in doubt.
- The recovered refrigerant shall be returned to the refrigerant supplier in the correct recovery cylinder, and the relevant Waste Transfer Note arranged. Do not mix refrigerants in recovery units and especially not in cylinders. If compressors or compressor oils are to be removed, ensure that they have been evacuated to an acceptable level to make certain that flammable refrigerant does not remain within the lubricant. The evacuation process shall be carried out prior to returning the compressor to the suppliers. Only electric heating to the compressor body shall be employed to accelerate this process. When oil is drained from a system, it shall be carried out safely.

4. Other Safety

Thank you for choosing a heat pump. This is a heat pump capable of providing the ideal comfort for your home, always with a suitable hydraulic installation. The unit is an air source heat pump for space heating/cooling and a sanitary water heater for houses, apartment blocks, and small industrial premises. Outdoor air is used as a heat source creating free energy to heat your home. This manual forms an essential part of the product and it must be given to the user. Read the warnings and recommendations in the manual carefully, as they contain important information on the safety, use, and maintenance of the installation.

This heat pump must be installed by qualified personnel only, in accordance with the legislation in force and following the manufacturer's instructions.

The start-up of this heat pump and any maintenance operations must be carried out only by qualified personnel only.

Incorrect installation of this heat pump could result in damage to people, animals or property, and the manufacturer will not be held liable in such cases.

The following safety precautions should always be taken into account:

- 1) Be sure to read the following WARNING before installing the unit.
- 2) Be sure to observe the cautions specified here as they include important items related to safety.
- 3) After reading these instructions, be sure to keep them in a handy place for future reference.
- 4) Equipment shall contain the following identification:



1. Control Panel



2. Operation Instru

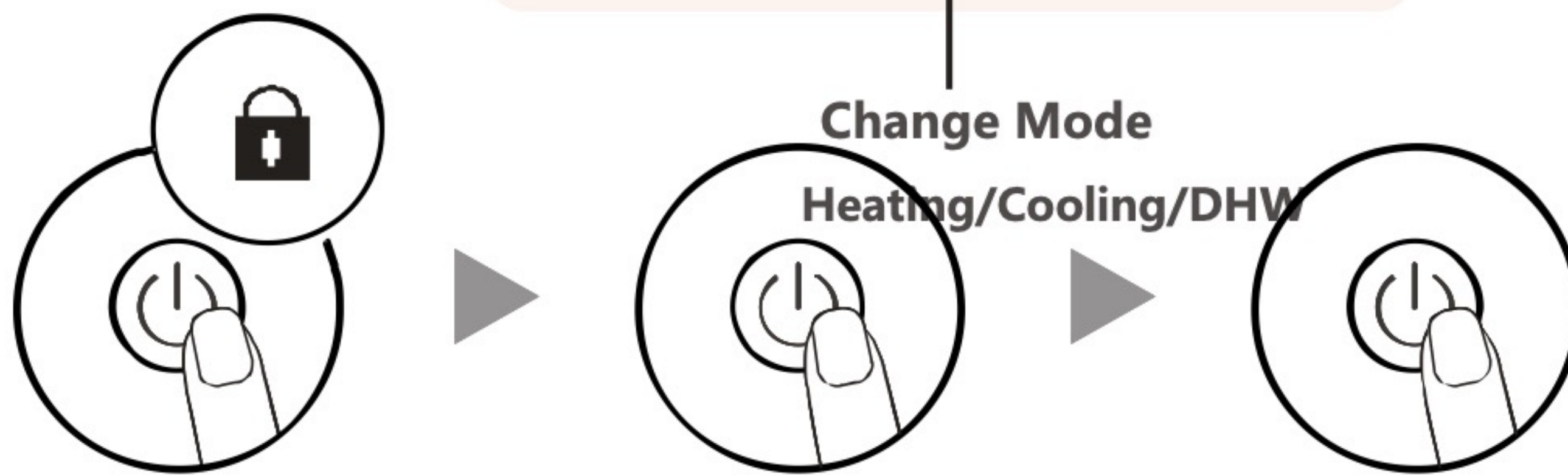

When the lock symbol is displayed, press and hold 5s to unlock the screen

Long press 2s to turn off the heat pump

Long press 2s to turn on the heat pump

Mode Setting

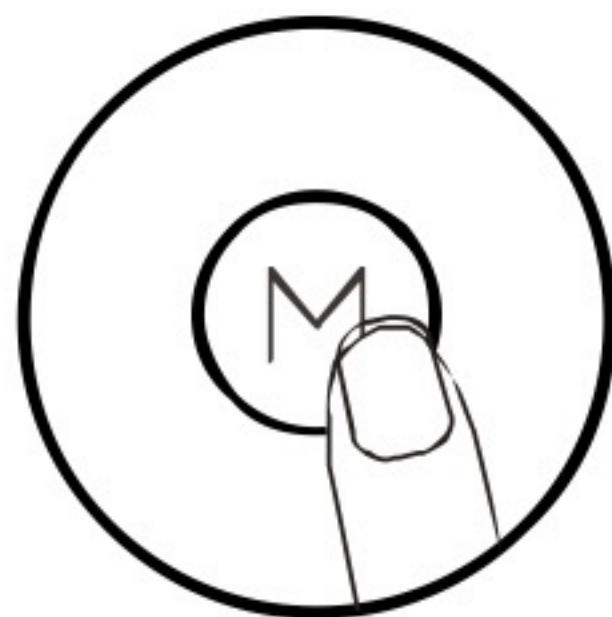

Press M to switch mode Cooling/Heating/DHW

Temperature Setting

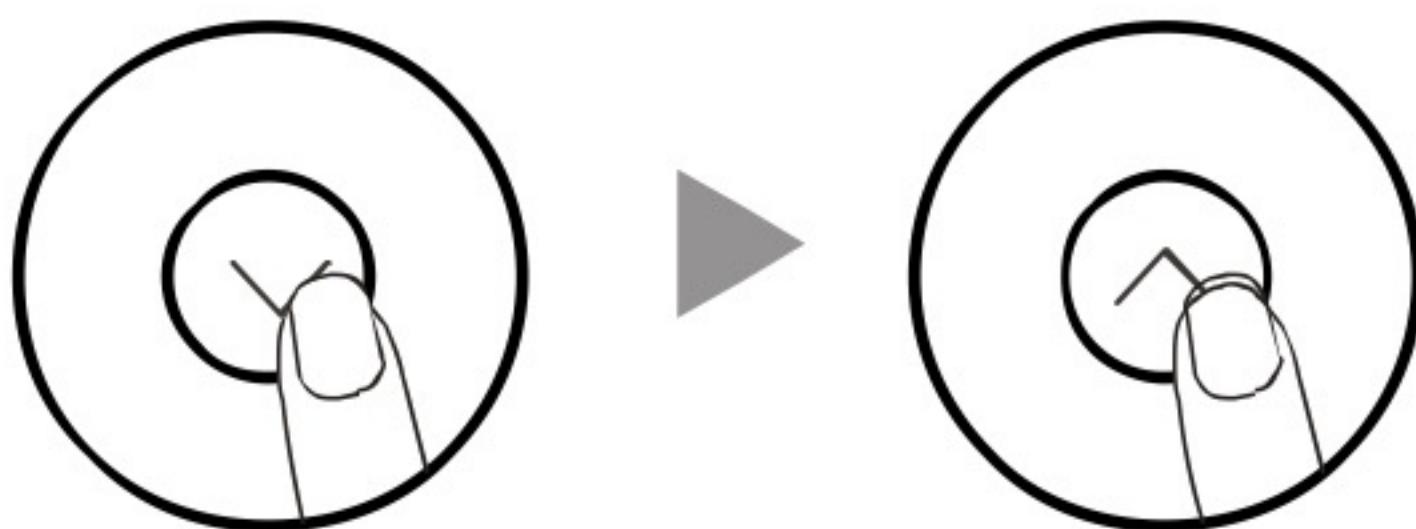

Press the up button to raise the temperature

Press the down button to lower the temperature

If there is no operation or press the on/off button within 5 seconds, the setting temperature will be saved automatically and return to the homepage

Time Setting

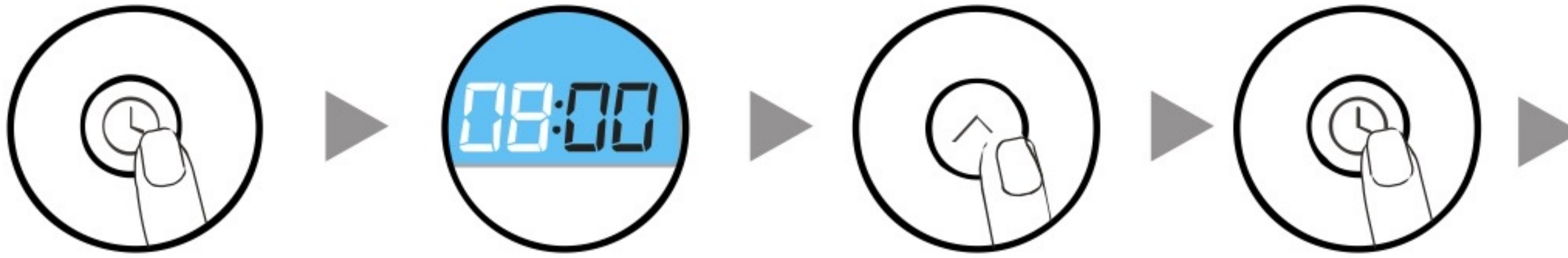

Press the clock button for 1s to enter the current clock setting

Press the clock key again, the hour area flashes

Press the up and down keys to adjust the value

Press the clock button again to enter the minute clock setting

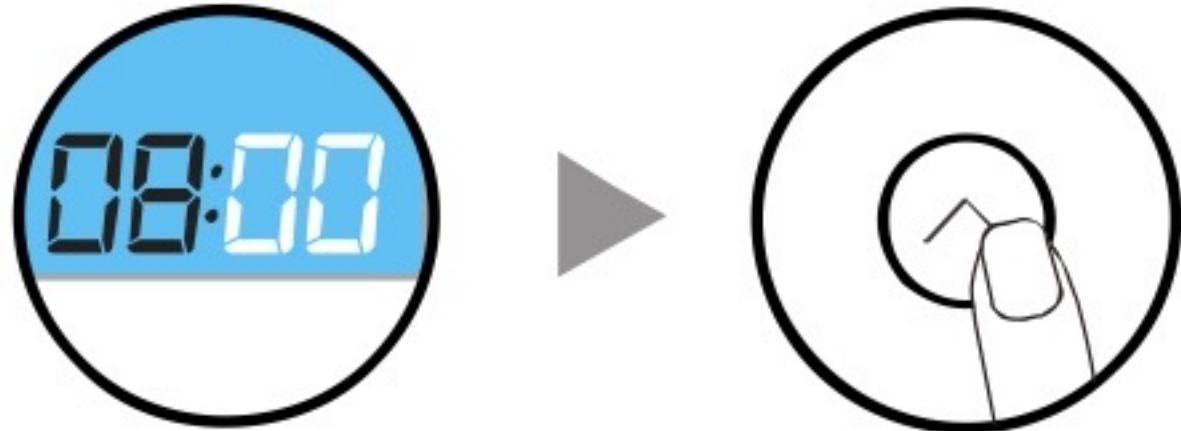

Press the clock button again, the minute area flashes

Press the up and down keys to adjust the value

If there is no operation or press the on/off button within 5 seconds, the setting temperature will be saved automatically and return to the homepage

Scheduled Power On

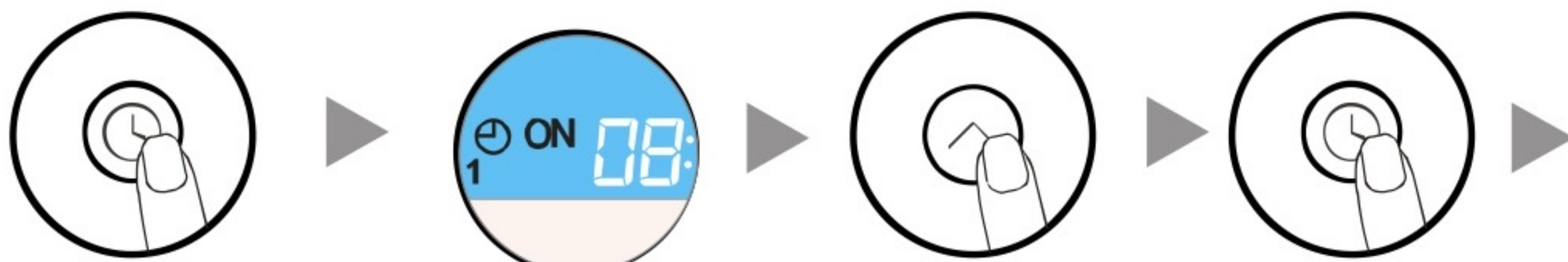

Press and hold the clock key for 5s to enter the timer boot time setting

Press the clock key again, the hour area flashes

Press the up and down keys to adjust the value

Press the clock button again to enter the minute clock setting

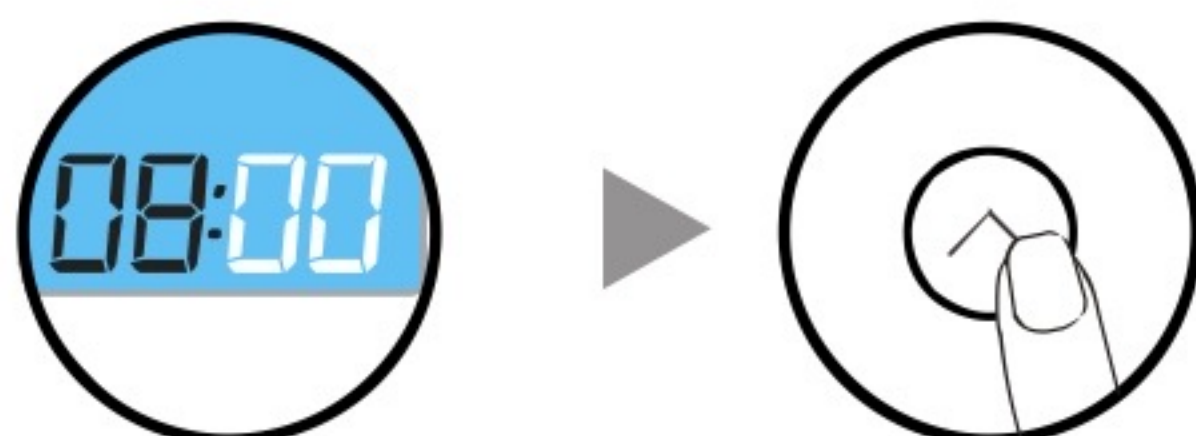

Press the clock button again, the minute area flashes

Press the up and down keys to adjust the value

If there is no operation or press the on/off button within 5 seconds, the setting temperature will be saved automatically and return to the homepage. Three timings can be set.

Status Search



Long press the down button for 5 s to enter the status search page

Enter the status search page

Adjust the status parameter serial number in combination with the up and down keys

ECO Mode

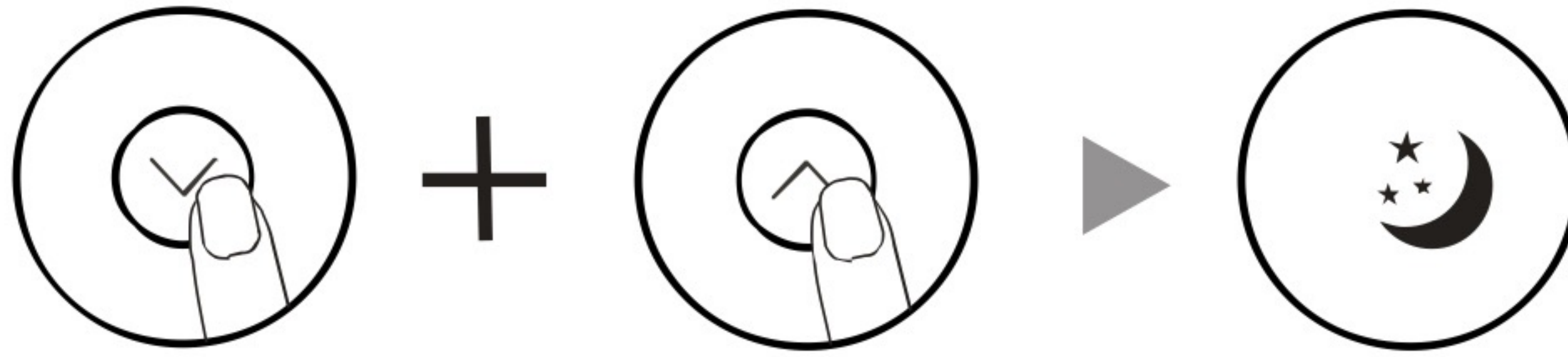

Unlock the case while holding down the up button + down button to enter ECO energy-saving mode

ECO symbol lit

Pump forced evacuation mode

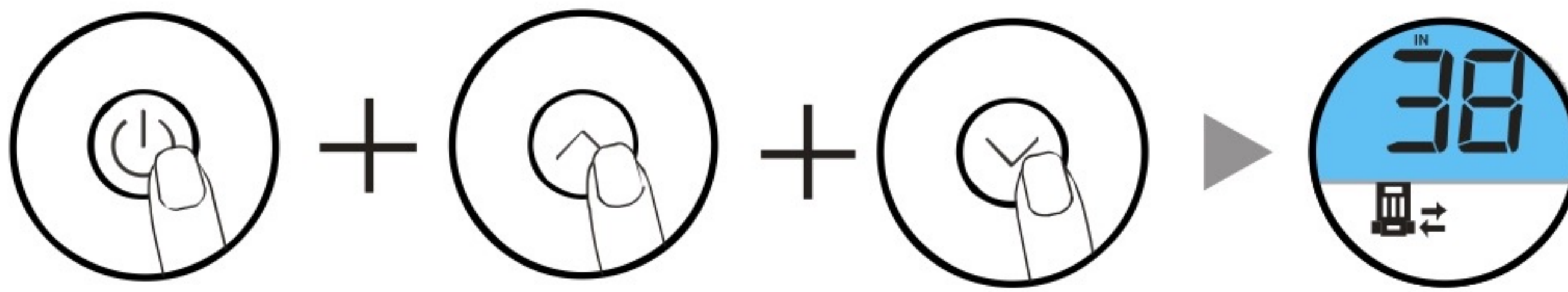

Press and hold the on/off button + up button at the same time in the unlocked state to enter the intelligent distribution mode

When the water pump symbol flashes enter forced emptying mode

3. Temperature and Climate Curve Setting

Setting Climate Temperature Curve

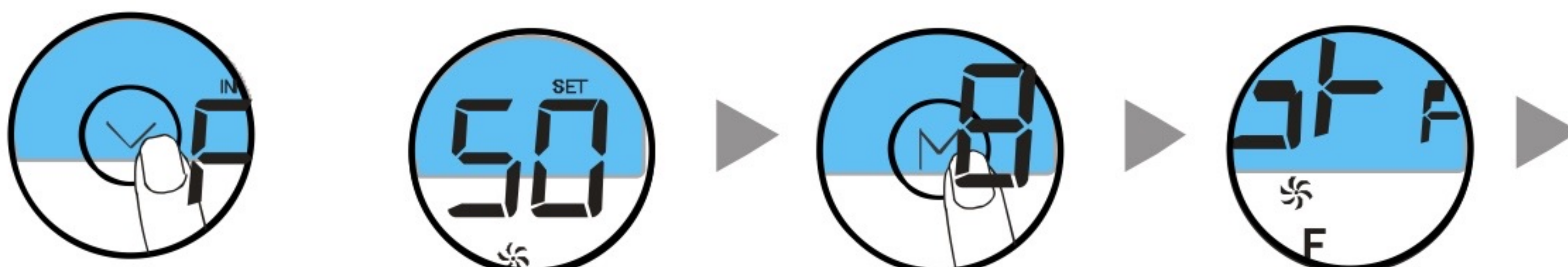

Press the key for 1s to enter the temperature setting interface

Set temperature flashing

Press and hold the M button again for 5s

Enter the temperature curve setting status to enable or disable the curve



When the climate temperature curve function is enabled, the user can select one of the eight curves in the main interface; curve 4 is the default curve, and curve 6 is the ECO energy-saving curve.

4. Wi-Fi Setting

4.1 Software Download and Account Registration

4.1.1 Search for  Smart Life in the app store on the mobile phone, and download and install it.

4.1.2 Users who do not have an account can apply by clicking the "Create New User" function on the login page.

4.1.3 Create a new account → Enter your cell phone number or email address, → get the verification code → to enter the verification code → set the password → complete, in the following order.

4.1.4 After registration is complete, you need to create a family: create a family, → set the family name → set the location → to add a room → ultimately, in the following order.

4.1.5 Click on the device name to enter the main interface of the device

- 1) Family name, which allows access to family management.
- 2) Adding devices.
- 3) Added room; click on it to view the devices added to that room.
- 4) Room management.

4.2 Connection (Intelligent Mode)

Manual Intelligent Distribution Network

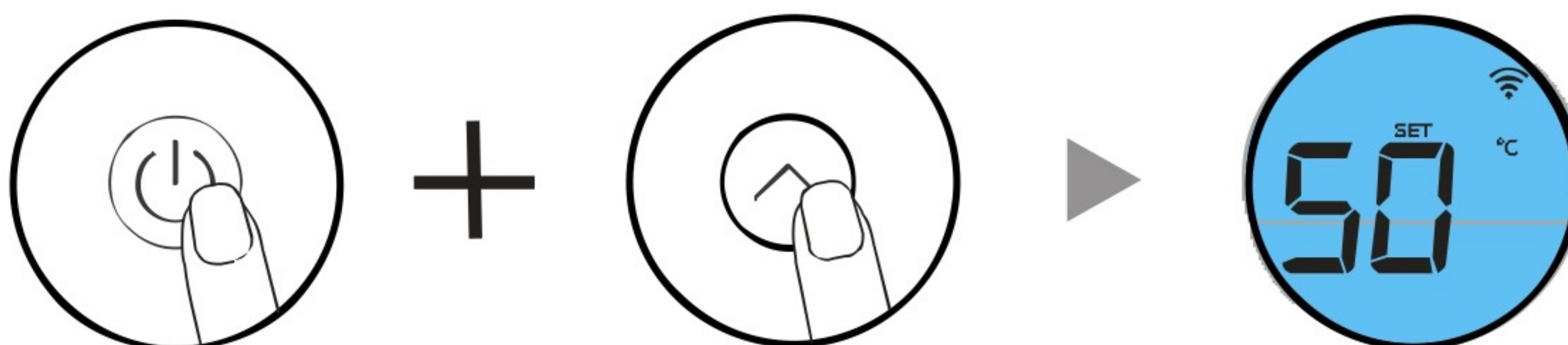

In the unlocked state, press and hold the on/off button + up button at the same time to enter the intelligent distribution mode

Wifi signal flashes
Enter distribution network status

Step 1

Open the "Smart Life" APP, login to the main interface, click the "lift" icon in the upper right corner to add devices or "Add Device" in the interface, enter the device type selection, and select "Smart Heat Pump (Wi-Fi)" in the "Main Appliance" device, enter the add device interface.

Step 2

Select Smart Heat Pump (Wi-Fi) and enter into the Wi-Fi connection interface, enter the Wi-Fi password that the phone has been connected to (must be the same as the Wi-Fi connection to the phone), click Next, and confirm that the line controller has selected the intelligent distribution mode, " " icon is fast-flashing, click "Confirm that the indicator is flashing, then start adding devices directly, click the "lift" icon to add devices.

Note: The icon flashes slowly when the Wi-Fi module is connected to the Wi-Fi hotspot.

Step 3

The system prompts "Add Device Successfully" and then the network is successfully distributed. Click on the icon in this interface to change the device name, select the device installation location (living room, main bedroom), and click Finish to enter the main interface of device operation.

4.3 Connection (AP Mode)

Manual AP Distribution Network

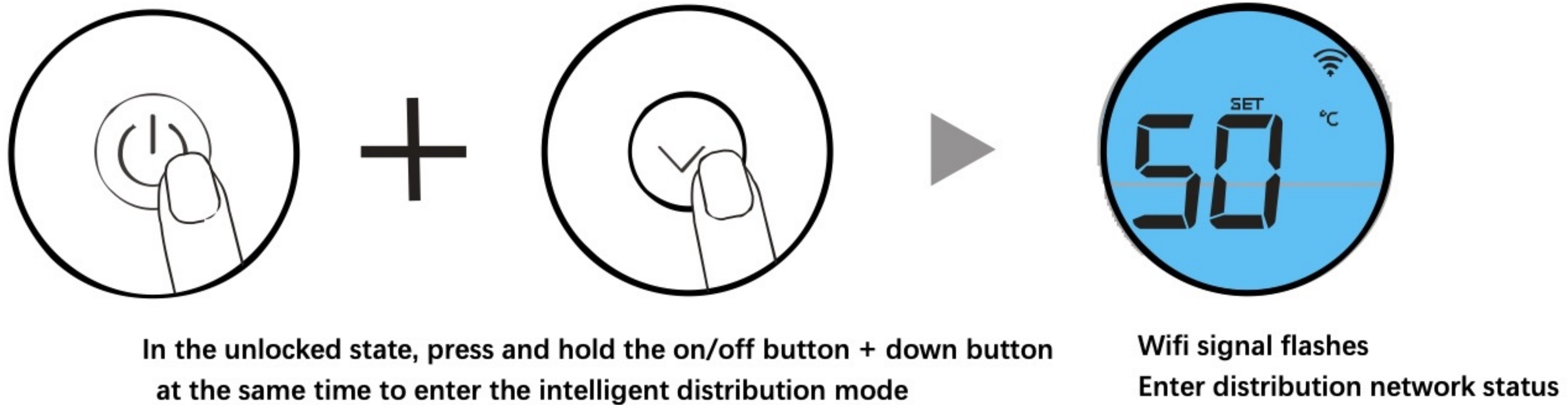

Step 1 and Step 2: Be consistent with the Intelligent Mode

Step 3

Select innovative heat pump (Wi-Fi) after entering into the Wi-Fi connection interface, enter the phone has been connected to the (Wi-Fi) password (must be consistent with the Wi-Fi connection to the phone), click next, confirm that the line controller has selected AP distribution mode, an icon in the slow flashing state " ", click "Confirm that the indicator is in slow flashing," then connect the phone Wi-Fi to the device hotspot (as shown below), confirm that the connection hotspot is correct to continue to the next step then directly begin to connect the device interface, find the device → registers to the cloud → device initialization is complete.

Note: When the wire Wi-Fi module is connected to the Wi-Fi hotspot, the icon " " slows flashing.

Step 4 The same as the Intelligent Mode

Note: If the connection fails, manually enter the AP network configuration mode again and repeat the preceding steps to connect again.

4.4 Software Function Operation

4.4.1 A device is automatically bound to a virtual gateway. The "My Home Heat Pump" (device name, which can be changed) operation page is displayed.

Buy a ticket to enter the device operation page of "My Home Heat Pump" by clicking on "My Home Heat Pump" in the "All Devices" screen of smart Life.

4.4.2 Modify device name and modify device location information Click "Name" to rename the device name and "Location" to alter the device location.

4.5 Device Sharing

Share bound devices in the following sequence:

- 1) After successful sharing, the list is added to display the shared person.
- 2) To delete the shared user, long-press the selected user, and the deletion interface will pop up, click "Delete"
- 3) User interface operations are as follows:
- 4) Enter the account of the shared user and click "Finish" to display the newly shared history in the list of successful sharing
- 5) The interface of the shared person is as follows. The shared device received is displayed. Click in to operate and control the device.

Operation Parameter Query

| Query Code | Description | Range |
|------------|---|--------------|
| 1 | Compressor Running Frequency | 0 ~ 150 Hz |
| 2 | Fan Motor Running Frequency | 0 ~ 999 Hz |
| 3 | Electronic expansion valve steps | 0 ~ 480 P |
| 4 | EVI valve steps | 0 ~ 480 P |
| 5 | AC Input Voltage | 0 ~ 500 V |
| 6 | AC Input Current | 0 ~ 50 A |
| 7 | Compressor Phase Current | 0 ~ 50 A |
| 8 | IPM temperature of the compressor | -40 ~ 140 °C |
| 9 | High-pressure saturation temperature | -50 ~ 200 °C |
| 10 | Low-pressure saturation temperature | -50 ~ 200 °C |
| 11 | External ambient temperature T1 | -40 ~ 140 °C |
| 12 | Outer coil (fin) T2 | -40 ~ 140 °C |
| 13 | Internal coil (plate heat exchanger) T3 | -40 ~ 140 °C |
| 14 | Gas Suction Temperature T4 | -40 ~ 140 °C |
| 15 | Gas Exhaust Temperature T5 | 0 ~ 150 °C |
| 16 | Water Inlet Temperature T6 | -40 ~ 140 °C |
| 17 | Water Outlet Temperature T7 | -40 ~ 140 °C |
| 18 | Economizer Inlet Temperature T8 | -40 ~ 140 °C |
| 19 | Economizer Outlet Temperature T9 | -40 ~ 140 °C |
| 20 | Machine Tooling No. | 0 ~ 120 |
| 21 | Water tank temperature | -40 ~ 140 °C |
| 22 | Fluorine plate heat exchanger out temperature | -40 ~ 140 °C |

| | | |
|----|---|---------------|
| 23 | Driver manufacturers | 0 ~ 10 |
| 24 | Water pump speed PWM | 0 ~ 100% |
| 25 | Water flow | 3 ~ 100 L/min |
| 26 | Return water temperature | -40 ~ 140 °C |
| 27 | Unit input voltage | 0 ~ 500 V |
| 28 | Unit input current | 0A ~ 99.99A |
| 29 | Unit input power | 0 ~ 99.99KW |
| 30 | Total electricity consumption of the unit | 0 ~ 9999 Kw.h |

Display Fault: When the machine has a fault, the fault is flashing in the timing area and the fault code is displayed cyclically; when the fault is eliminated, the standard display is restored.

Dimension

1. Dimension

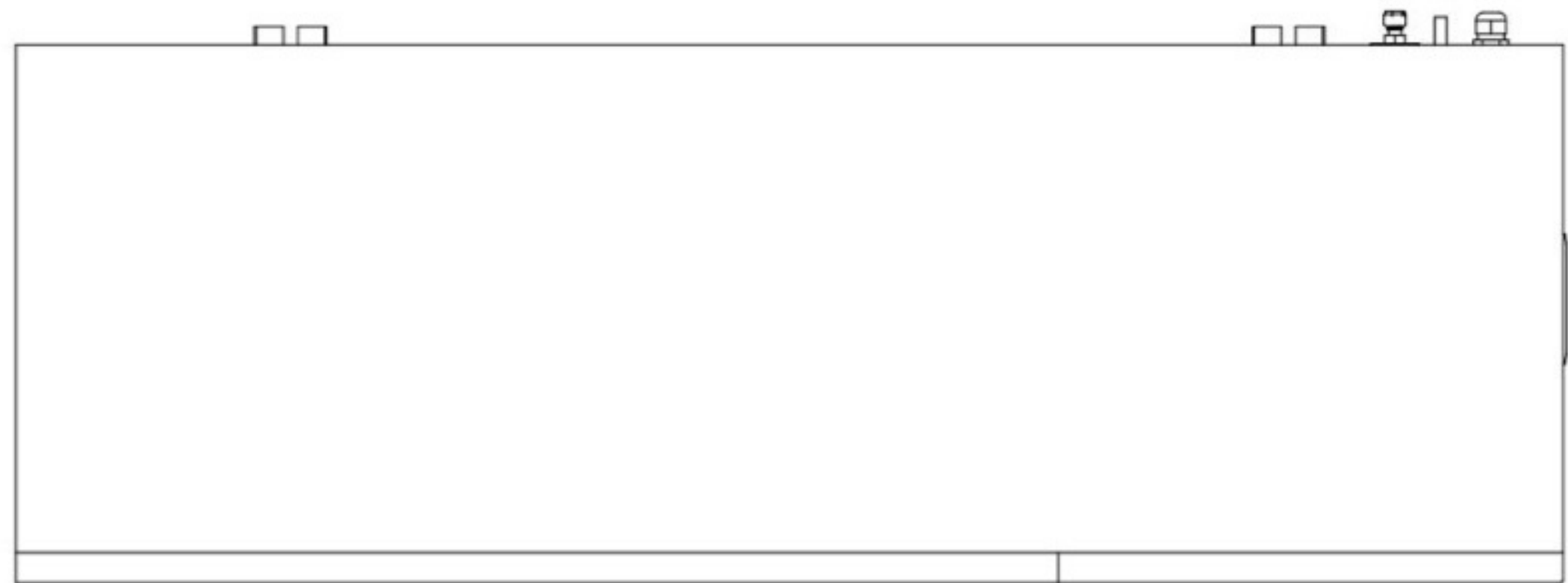
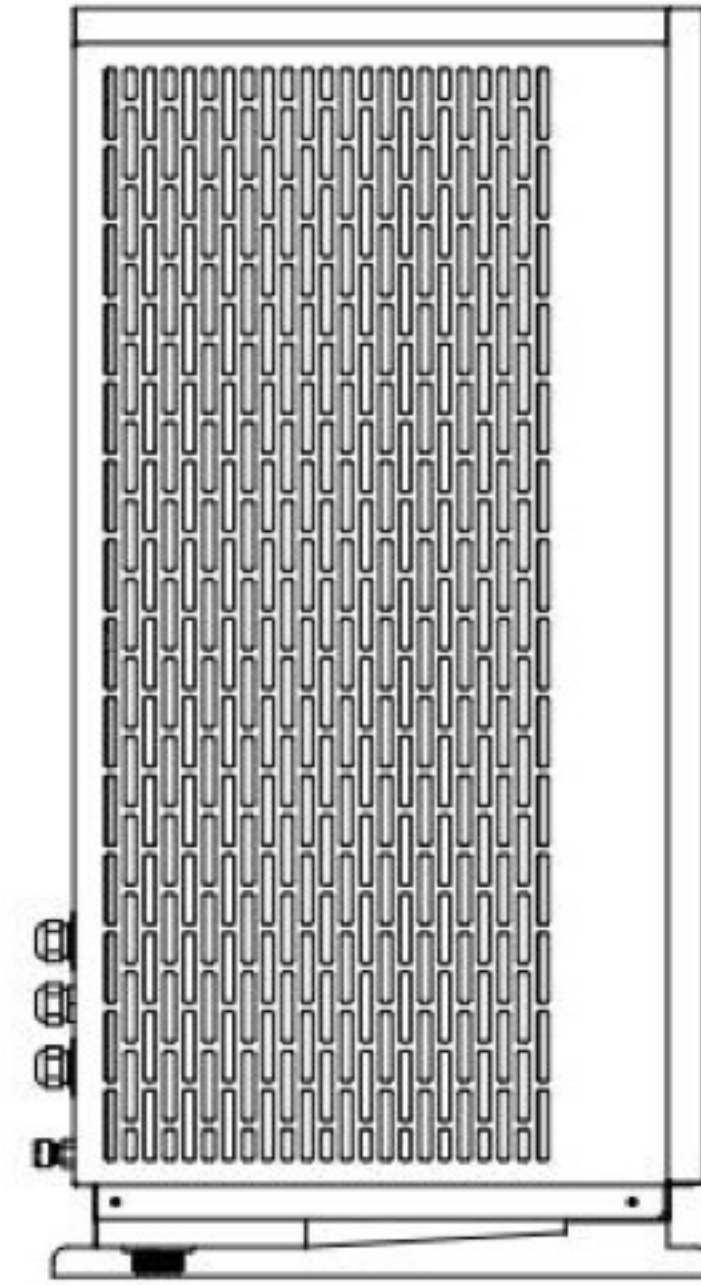
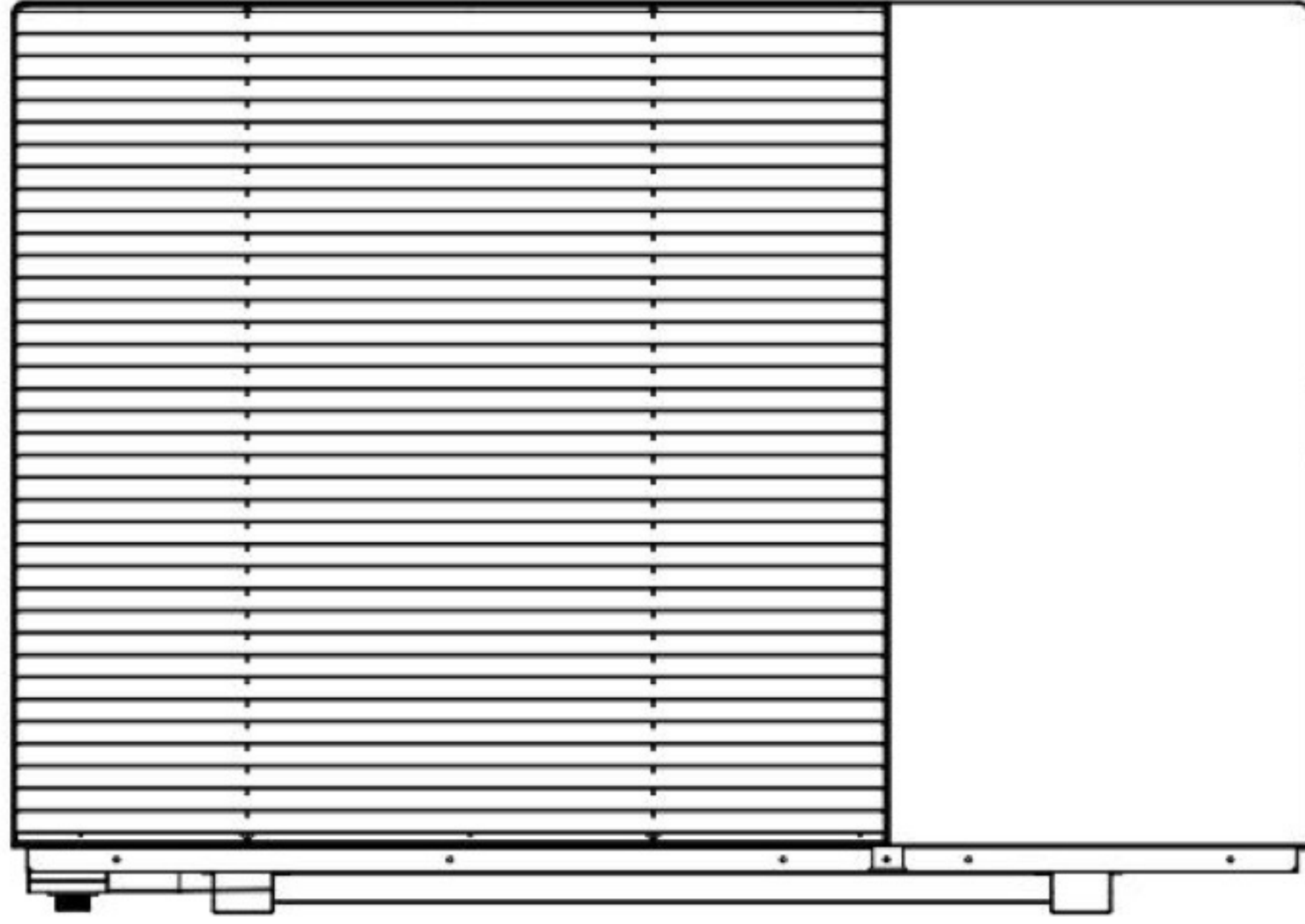

| Model | Packed Dimensions (mm) |
|-------|------------------------|
| One | 1217*463*920 |
| One+ | 1317*493*1020 |

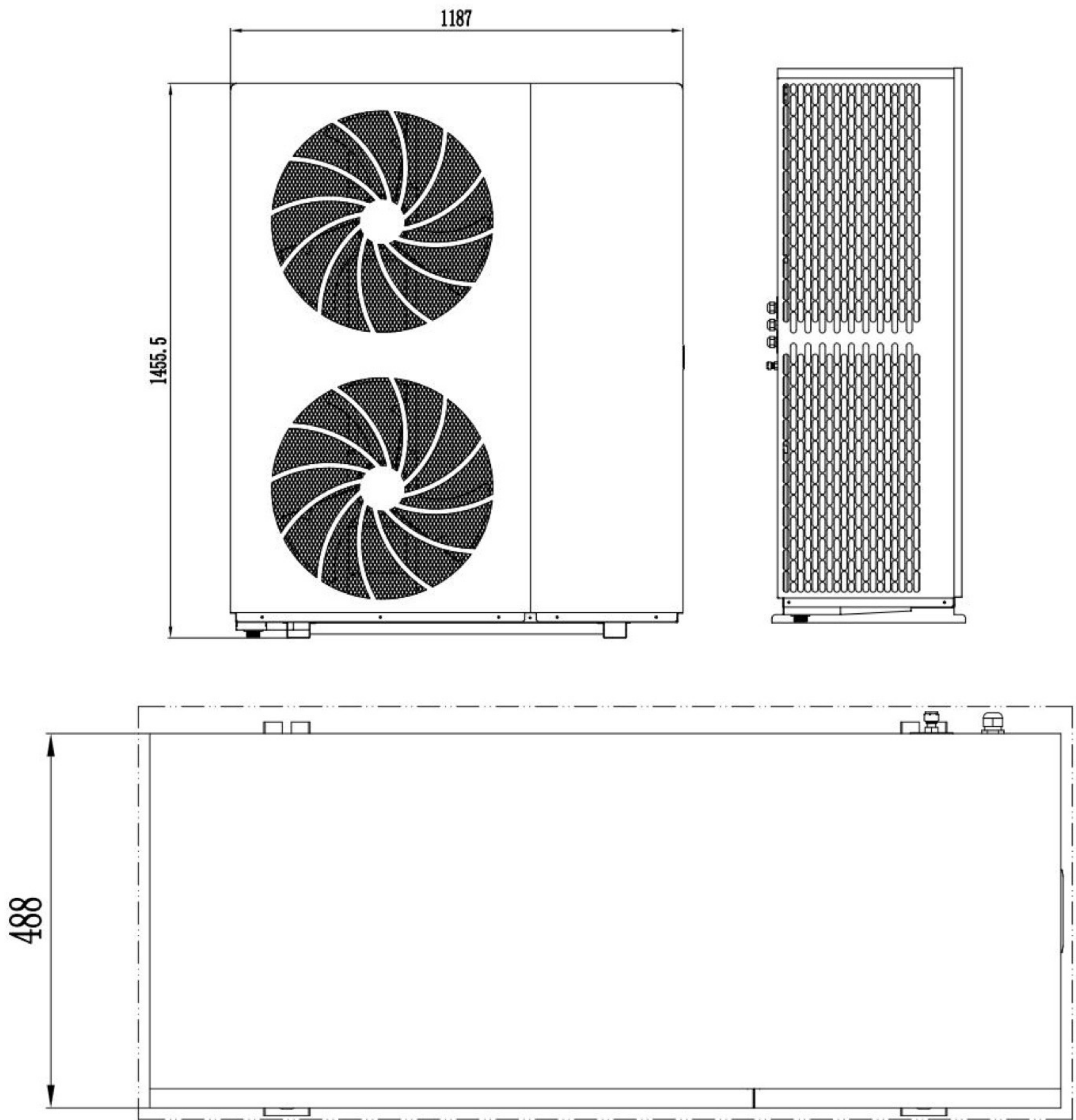

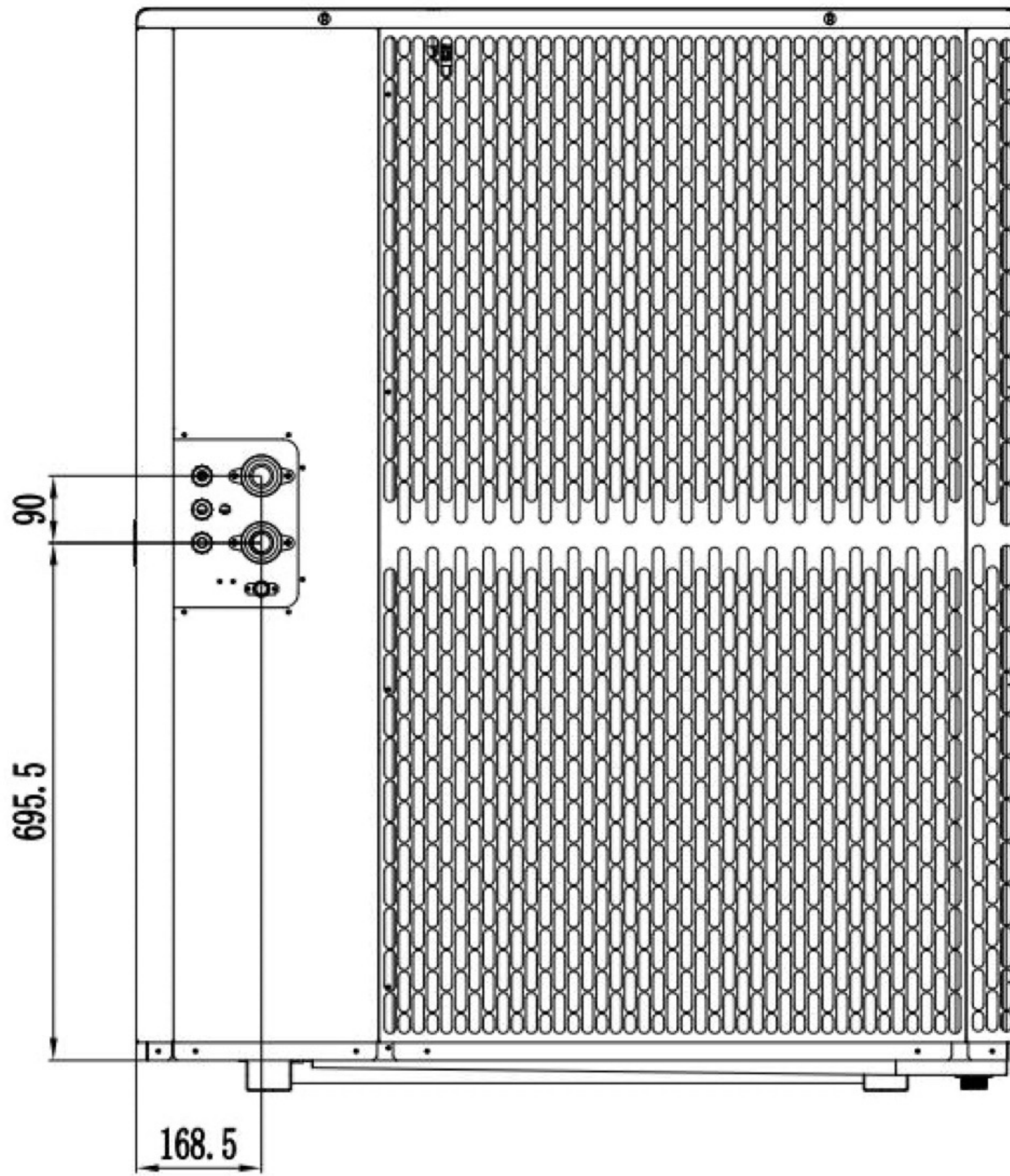

| Model | Packed Dimensions (mm) |
|-------|------------------------|
| PRO | 1217*538*1570 |

2. Explosive Diagram

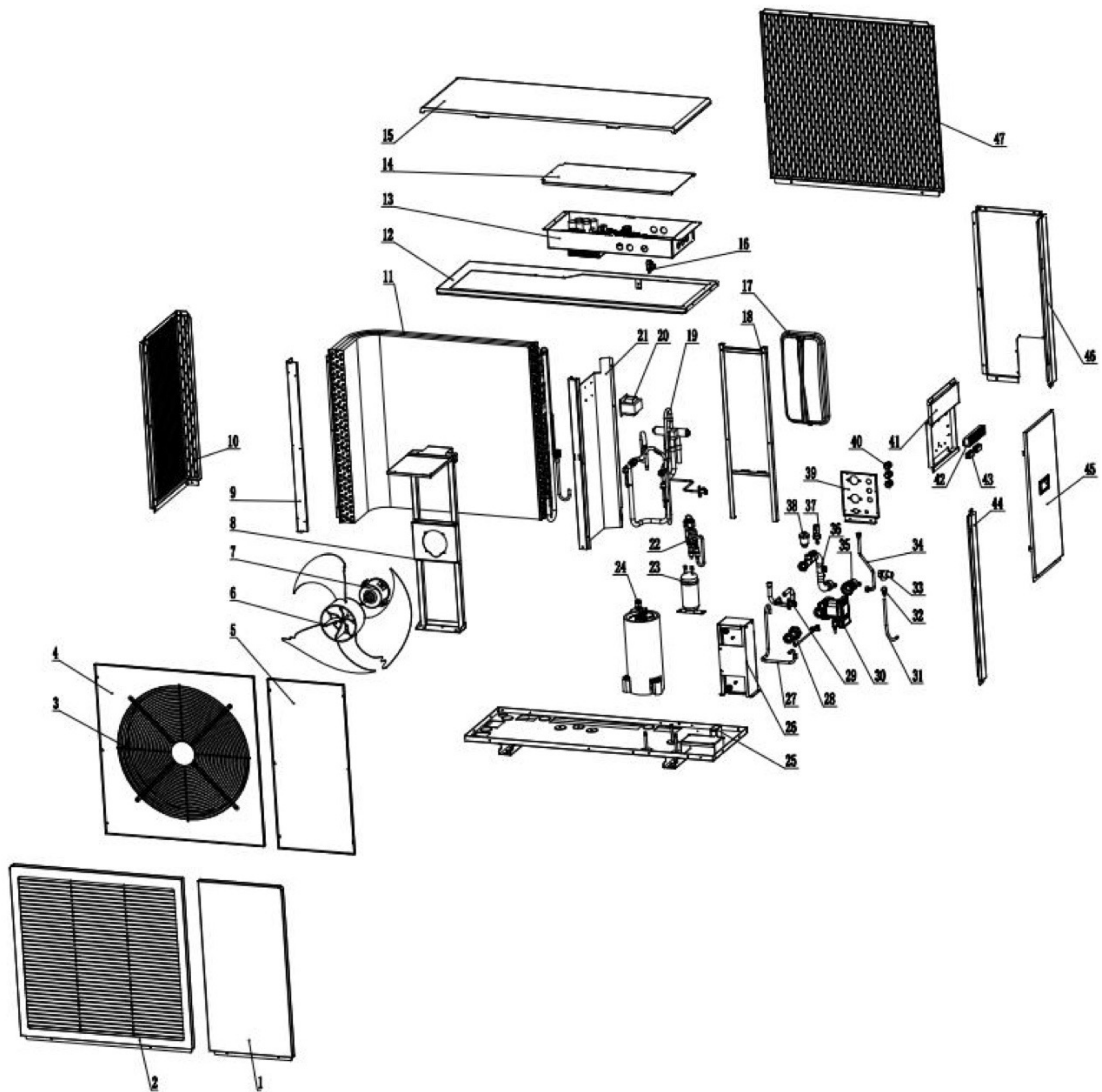

| Number | Description | Number | Description |
|--------|--------------------------|--------|----------------------------------|
| 1 | Front right panel | 24 | Compressor |
| 2 | Front left panel | 25 | Base panel Components |
| 3 | Air outlet grille | 26 | Plate heat exchanger |
| 4 | Baffle | 27 | Plate heat exchanger refrigerant |
| 5 | Maintenance panel | 28 | Plate heat exchanger inlet pipe |
| 6 | Fan blade | 29 | Plate heat exchanger refrigerant |
| 7 | Fan motor | 30 | Water pump |
| 8 | Motor bracket | 31 | Drain pipe |
| 9 | Left-side column | 32 | Drain connector |
| 10 | Left-sidepanel | 33 | Safety valve |
| 11 | Probe Clamp | 34 | Expansion tank pipeline |
| 12 | Plastic Waterproof Joint | 35 | Water pump inlet pipe |
| 13 | Junction Plate 2 | 36 | Plate heat exchanger outlet pipe |
| 14 | Junction Plate 3 | 37 | Flow switch |

| | | | |
|----|-------------------------|----|------------------------|
| 15 | Right-side Plate | 38 | Auto exhaust valve |
| 16 | Clip | 39 | Fixed plate |
| 17 | Expansion tank | 40 | Waterproof connector |
| 18 | Expansion Tank Bracket | 41 | Terminal block bracket |
| 19 | Four-way valve assembly | 42 | Terminal block |
| 20 | Reactor | 43 | Wire clip |
| 21 | Middle partition | 44 | Right column |
| 22 | Throttle parts | 45 | Right side panel |
| 23 | Reservoir | 46 | Right rear side panel |

Installation

1. Installation Preparation

1.1 Install The Required Tools (Self-Provided)

| Number | Tool | Number | Tool |
|--------|-------------------|--------|-------------------------------|
| 1 | Level | 10 | Saw |
| 2 | Electric Hammer | 11 | Flat Blade Screwdriver |
| 3 | Adjustable Wrench | 12 | Cross Screwdriver |
| 4 | Needle-nose Plier | 13 | Copper Tube Knife |
| 5 | Impulse Drill | 14 | PP-R Tube Knife |
| 6 | Ruler | 15 | PP-R Tube Heat Melting Device |
| 7 | Torque Wrench | 16 | Compound Gauge |
| 8 | Hexagonal Wrench | 17 | Vacuum Pump |
| 9 | Hammer | 18 | Electronic Balance |

1.2 Connecting Wires, Insulation Materials, PP-R Pipe, And Connector

- a) The material and thickness of the insulation pipe meet the specified requirements. Otherwise, heat loss and condensation will be caused.
- b) Please refer to this manual's "Electrical Installation" description section for wire size selection.

| Model | The water inlet/outlet size |
|-------|-----------------------------|
| ONE | DN25 (1") |
| ONE+ | DN25 (1") |
| PRO | DN40 (1.5") |

1.3 Other Installation Materials

- a) Fix the pipe bracket and pipe clamp of the connecting pipe
- b) Wire threading pipe and pipe clamp
- c) Insulating tape, raw tape
- d) Expansion bolt
- e) Mounting bracket

2. Heat Pump Installation

- 2.1 The machine installation space meets the following schematic requirements to ensure regular air circulation and maintenance;
- 2.2 The location of the machine should be kept away from heat, steam, or flammable gases;
- 2.3 Do not install the machine in places with strong wind or dust;
- 2.4 Do not install the machine where it is often passed through the air suction side and air exhaust side;
- 2.5 The installation position of the machine should be adequately drained to the nearby sewer.

Heat Pump Installation Space Diagram

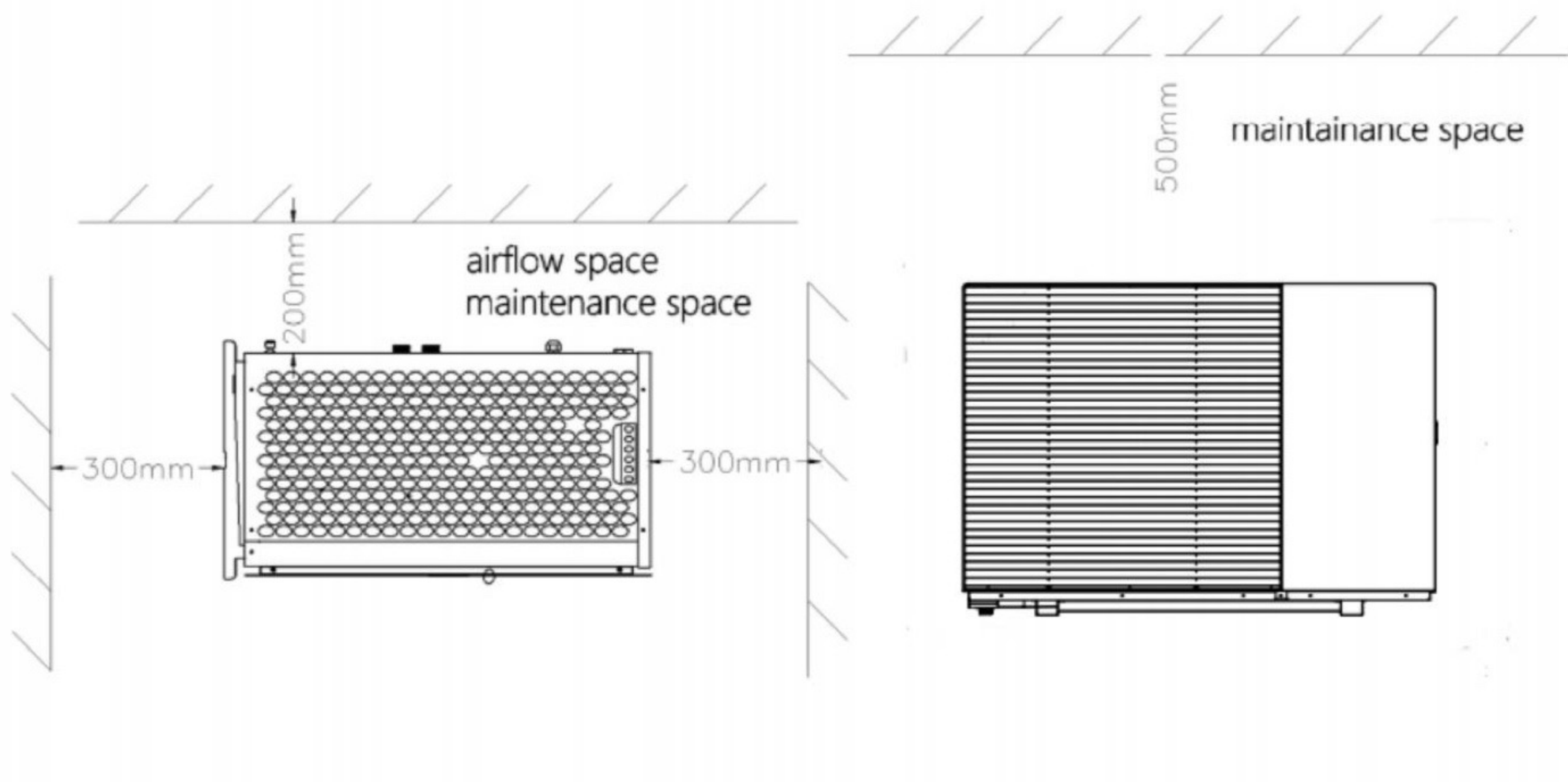

Note

Installation In The Following Locations May Cause The Machine To Malfunction:

1. A place with more oil;
2. Wet place
3. Seaside saline-alkali area;

-
4. Special environmental conditions;
 5. High-frequency facilities such as wireless equipment, welding machines, and medical equipment.

3. Outdoor Unit Specific Installation Steps

- 3.1 Install the unit on a solid surface such as concrete, and the load-bearing cover or mounting bracket must meet the strength requirements;
- 3.2 Fasten the outdoor unit to the mounting bracket with bolts and nuts and keep it level;
- 3.3 If installed on a wall or a roof, the bracket must be firmly fixed to prevent damage caused by an earthquake or strong wind;
- 3.4 The positioning dimension of the outdoor unit installation base is 810*394mm. It is required to install four-position foot bolts with a diameter of 10mm—at the bottom of the installation of the outdoor unit. The inch recommendation is 1200*450mm.

Installation Precautions

1. The unit should be installed so that the inclination of any vertical surface does not exceed 5 degrees;
2. Do not install the outdoor unit directly on the ground;
3. The strength of the ordinary air-conditioning bracket may not apply to the unit. Please design or select the frame according to the weight of the team;
4. If the mainframe is installed and fixed on the open balcony and the roof, it is necessary to lift the unit. Pay attention to the following points when lifting:
 - 4.1 Please use four or more soft slings to lift the handling unit;
 - 4.2 To avoid scratching and deformation of the surface of the unit, please install the guard plate on the surface of the team during lifting and loading;
 - 4.3 Before final installation, it is necessary to check whether the foundation is correct or not, in case it is wrong with the actual object.

4. User Water System Installation

- 4.1 The Installation Of The Water System Must Meet The Following Principles:
 - 4.1.1 Pipe length is as short as possible;
 - 4.1.2 Pipe diameter must meet the requirements of the unit;
 - 4.1.3 The elbows on the waterway are as few as possible, and the elbow radius is as large as possible;
 - 4.1.4 The thickness of the water pipe insulation layer meets the specified requirements;
 - 4.1.5 Dust and debris should not enter the pipeline system as much as possible;
 - 4.1.6 The unit must be fixed before the piping system can be installed.

Remarks:

1. Hydraulic calculation must be carried out after the primary water pipe selection is completed. If

the waterside pipeline resistance is more excellent than the selected pump lift, the larger water pump must be re-selected, or the water pipe must be increased in size;

2. When multiple units are connected in parallel, the primary and circulating water pumps must be selected as appropriate according to the hydraulic calculation requirements.

Remarks:

1. The same piping design is allowed to distribute the water evenly.
2. The system must be equipped with an automatic water supply valve, and the highest point of the water system must be equipped with an automatic pressure relief valve;
3. The drain valve shall be installed at the bottom of the pipeline to facilitate drainage;
4. The pressure relief valve is installed at the highest point of the system pipeline, and the terminal of the water pipe must have an expansion diameter;
5. Normal working water capacity can ensure normal defrosting in winter (ensure that the water capacity per kW exceeds 10L);
6. The machine has been equipped with a water flow switch; users do not need to install one more;
7. To facilitate the maintenance of the machine, a pressure gauge is required to be installed for the outlet pipe of the device;
8. If the compartment controls the floor heating, and the number of the manifolds in the smallest area is less than or equal to 2, please install the differential pressure bypass valve according to the schematic diagram;

4.2 Water Quality Requirements By The Machine

4.2.1 When water quality is not good, it will produce some scale and sediment such as sand. Therefore, the water used must be filtered and softened with soft water equipment before it flows into the heat pump water system;

4.2.2 Please analyze the water quality before using the machine, such as PH value, conductivity, chloride ion concentration, sulfur ion concentration, etc.

| PH | Water Hardness | Conductivity | S | Cl | Nh4 |
|--------|----------------|-----------------|-----|---------|-----|
| 7~8.5 | <50ppm | <200vV/cm(25°C) | N/A | <500ppm | N/A |
| So4 | Si | Iron content | Na | Ca< | |
| <50ppm | <30ppm | <0.3ppm | N/A | <50ppm | |

4.3 Water Pipeline Installation Instructions

- 4.3.1 Install all water pipelines;
- 4.3.2 Check if any water leaks in the pressurized pipelines;
- 4.3.3 Clean the water pipelines.

4.4 Water Pipeline Feed-Water And Pipeline Emptying Steps:

- 4.4.1 Open the pressure relief valve on the water distributor and all valves;
- 4.4.2 Feed the water at the pipe filling port;
- 4.4.3 During the feed-water process, it is necessary to observe if the pressure relief valve or the drain valve has water overflow, and if there is water overflow, it means that the water in the system has been filled;
- 4.4.4 Close the pressure relief valve, and then look at the water pressure gauge. If the pressure value is more than 0.15Mpa, please close the feed-water valve and complete the water

drain.

5. Selection and Installation of Water System Accessories

5.1 Selection Of Circulating Pump

5.1.1 The machine must be installed with a circulating pump to be used. The heat pump provides the power port of the circulating pump (single-phase power supply). Please refer to the circuit diagram for wiring. The maximum power of the circulating pump is not allowed to exceed 1.5 kW.

5.1.2 Please select the circulating pump according to the actual lift required, and the flow must be guaranteed to meet the requirements of the machine nameplate.

5.2 Selection Of Auxiliary Electric Heater

5.2.1 The user can select the auxiliary electric heater if needed; however, the machine only provides the port connected with a signal wire to control the auxiliary electric heater.

5.2.2 Professionals must install the installation of an auxiliary electric heater.

5.3 Selection Of Water Flow Switch: The machine has a built-in flow switch, so it does not require one more water flow switch.

5.4 Other Optional Accessories Recommended

| Accessories | Description | Remark |
|----------------|---------------|-------------------------|
| Buffer Tank | 60L or bigger | |
| Expansion Tank | 5 L | Only Pressurized System |
| Pressure Gauge | 1.5 Mpa | |
| Safety Valve | 0.3 Mpa | Only Pressurized System |

6. Electrical Installation

All wiring and grounding must comply with local electrical codes.



Note

1. The specification label should be carefully checked to ensure that the wiring meets the specified requirements and is correctly wired according to the wiring diagram;
2. The auxiliary electric heater must be equipped with an independent current circuit breaker and leakage protector;
3. The power supply must meet the requirements of the machine and must be reliably and effectively wired;
4. Wires should not be in contact with copper pipes, compressors, motors, or other operating components;
5. Do not change the internal wiring of the machine without permission. Otherwise, the seller will not commit any responsibility;
6. Do not change the internal wiring of the machine without permission. Otherwise, the seller will not commit any responsibility;
7. Do not send power before the wiring is completed to avoid personal injury;

8. The supply voltage should vary within $\pm 10\%$ of the standard value.
9. Electrical specifications:

| c | One | One+ | PRO |
|--------------------------------|-----------|----------------|----------------|
| Power Supply | 220~240 V | 380~415/3/50hz | 380~415/3/50hz |
| Max Input Current (A) | 12 | 17 | 35.50 |
| Fuse Rated Current(A) | 12 | 17 | 36 |
| Air Switch (mA) | 25 | 25 | 50 |
| Power Cable (mm ²) | 4.00 | 4.00 | 6.00 |

Power Cable And Signal Wire Connection Instruction

1. Remove the machine's front cover and connect the wire to the corresponding terminal block according to the electrical wiring diagram to confirm that the connection is secure.
2. Secure the cable with the wire clamp and install the service plate.
3. Do not connect the wrong line. Otherwise, it will cause electrical failure or even damage the machine.
4. The type and rating of the fuse are based on the specifications of the corresponding controller or fuse cover.
5. The power cable must be selected and installed by a professional installer. When the installer chooses the power cable, the power cable should not be lighter than the neoprene armoured cord (line 57 of IEC 60245). For specific power cable specifications, see the electrical specifications.
6. If the user's power distribution capacity is insufficient or the power cord (copper core wire) is not configured as required, the machine cannot be started or operated normally. The seller will not take any responsibility.

Motherboard Output Definitions

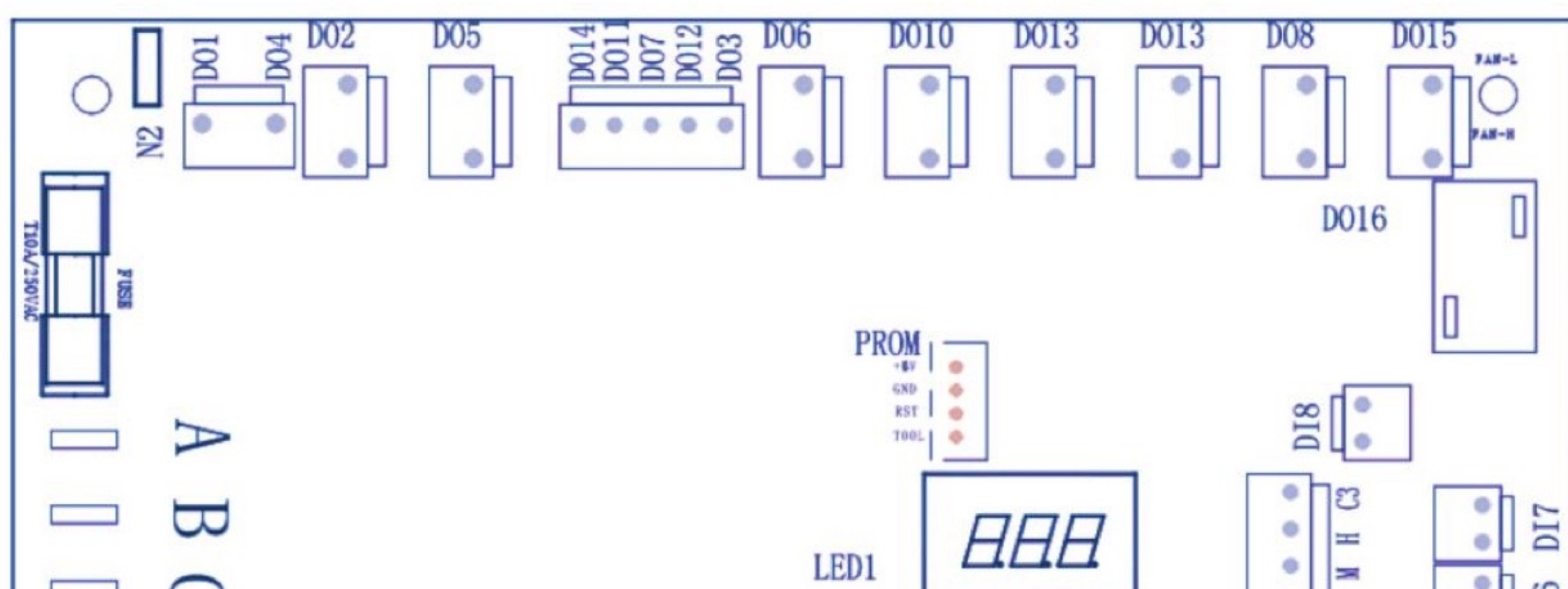

| Seq. | Port | Description | Seq. | Port | Description |
|------|------|-----------------------------|------|------|------------------------------------|
| 1 | D01 | Hot Water Electric Heating | 35 | A13 | Low-Pressure Sensors |
| 2 | D02 | Four-Way Valve | 36 | T1 | Outer Coil Temperature |
| 3 | D03 | Liquid Injection Valve | 37 | T2 | Return Air Temperature |
| 4 | D04 | Reservation | 38 | T3 | Exhaust Temperature |
| 5 | D05 | Reservation | 39 | T4 | Cooling Coil Temperature |
| 6 | D06 | Return Water Valve | 40 | T5 | Economizer Inlet Temperature |
| 7 | D07 | Crankshaft Heating | 41 | T6 | Economizer Outlet Temperature |
| 8 | D08 | Chassis Heating | 42 | T7 | Outdoor Ambient Temperature |
| 9 | D09 | Heating Electric Heating | 43 | T8 | Water Inlet Temperature |
| 10 | D010 | Hot Water Valve Off | 44 | T9 | Reservation |
| 11 | D011 | Hot Water Valve On | 45 | T10 | Reservation |
| 12 | D012 | Air-Conditioning Valve Open | 46 | T11 | Reservation |
| 13 | D013 | Air-Conditioning Valve Off | 47 | T12 | Reservation |
| 14 | D014 | Enthalpy Valve | 48 | T13 | Return Water Temperature |
| 15 | D015 | Low Wind (AC) | 49 | T14 | Freeze Protection Temperature |
| 16 | D016 | High Wind (AC) | 50 | T15 | Water Discharge Temperature |
| 17 | D017 | Circulating Water Pump | 51 | T16 | Water Tank Temperature (Hot Water) |
| 18 | C2 | Public Side1 | 52 | COM3 | Drive Module |
| 19 | C1 | Public Side2 | 53 | COM4 | LCD In-Line Controller |
| 20 | D18 | Medium Voltage Switch 1 | 54 | COM3 | Reservation |
| 21 | D17 | Reservation | 55 | COM2 | Uplink Monitoring And Control |
| 22 | D16 | Linkage Switch | 56 | COM1 | Module Cascade |
| 23 | D15 | Reservation | 57 | ECL | Extension Modules |
| 24 | D14 | Reservation | 58 | 12V | DC 12V Power Supply |
| 25 | D13 | Water Flow Switch | 59 | EXV1 | EEV Main Valve |
| 26 | D12 | Low Voltage Switch | 60 | EXV2 | Auxiliary Valves |
| 27 | D11 | High Voltage Switch | 61 | EXV3 | Reservation |
| 28 | C3 | Water Level Public End | 62 | EXV4 | Reservation |

| | | | | | |
|----|-----|--------------------------------|----|------|-----------------------|
| 29 | H | High Water Level (Hot Water) | 63 | N | Power Input Zero Line |
| 30 | M | Medium Water Level (Hot Water) | 64 | C | Power Input T-Phase |
| 31 | L | Low Water Level (Hot Water) | 65 | B | Power Input S-Phase |
| 32 | A12 | Reservation | 66 | A | Power Input R-Phase |
| 33 | A11 | Reservation | 67 | LED1 | 8-Bit Dialing Code |
| 34 | A14 | High-Pressure Sensors | | | |

Expansion Board Output Definition

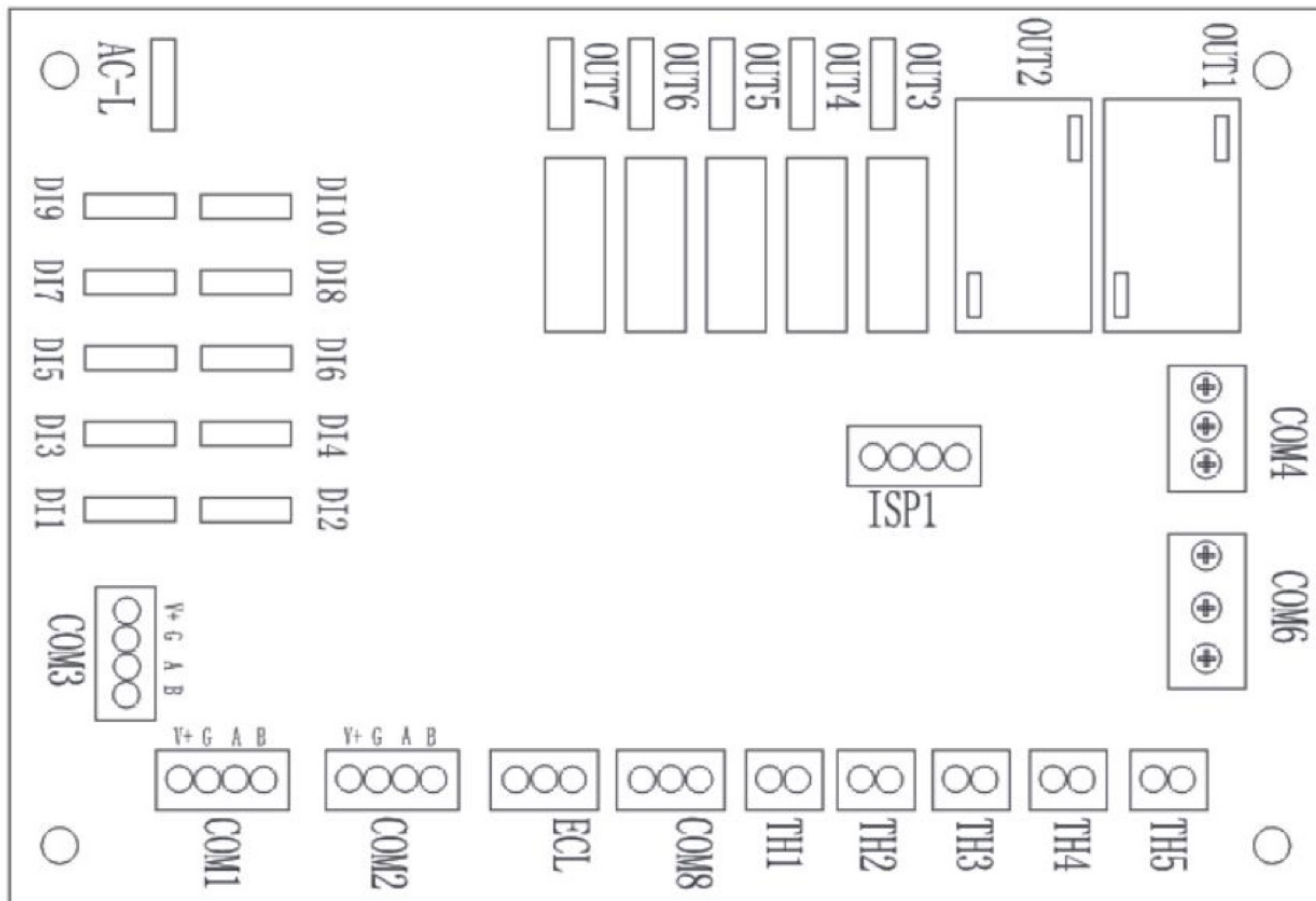

| Seq | Port | Description | Seq | Port | Description |
|-----|------|----------------------------|-----|------|-------------------------|
| 1 | OUT1 | Circulating Water Pump | 18 | D16 | Forced Hot-Water Switch |
| 2 | OUT2 | Hot Water Electric Heating | 19 | D15 | Gnd |
| 3 | OUT3 | Air-Conditioning Valve Off | 20 | D14 | Linkage Switch |
| 4 | OUT4 | Air-Conditioning Valve On | 21 | D13 | Gnd |
| 5 | OUT5 | Hot Water Valve On | 22 | D12 | Water Flow Switch |
| 6 | OUT6 | Hot Water Valve Off | 23 | D11 | Gnd |
| 7 | OUT7 | Reservation | 24 | TH1 | Water Inlet Temperature |

| | | | | | |
|----|------|------------------------------|----|------|-------------------------------|
| 8 | D08 | Chassis Heating | 25 | TH2 | Water Outlet Temperature |
| 9 | D09 | Electric Heating For Heating | 26 | TH3 | Water Tank Temperature |
| 10 | D010 | Hot Water Valve Off | 27 | TH4 | Cooling Coil Temperature |
| 11 | D011 | Hot Water Valve On | 28 | TH5 | Freeze Protection Temperature |
| 12 | D012 | Air-Conditioning Valve On | 29 | COM8 | Water Flow Meter |
| 13 | D013 | Air-Conditioning Valve Off | 30 | ECL | Serial Communication |
| 14 | D110 | Forced Cooling Switch | 31 | COM2 | Rs485 |
| 15 | D19 | Gnd | 32 | COM2 | Rs485 |
| 16 | D18 | Forced Heating Switch | 33 | COM1 | Rs485 |
| 17 | D17 | Gnd | 34 | AC-L | Firewire Input |

Wire Diagram

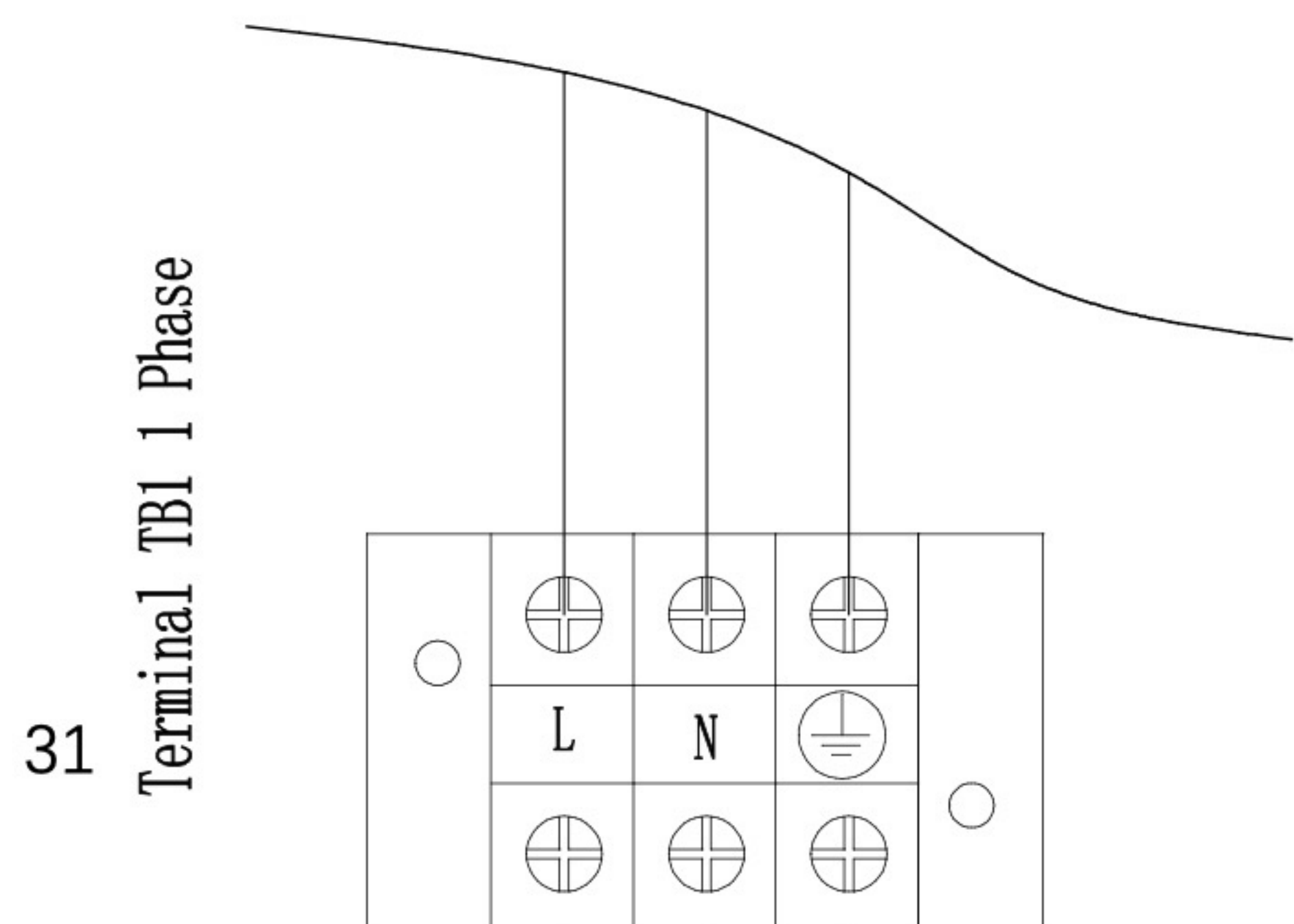

Terminal TB1 3 Phase

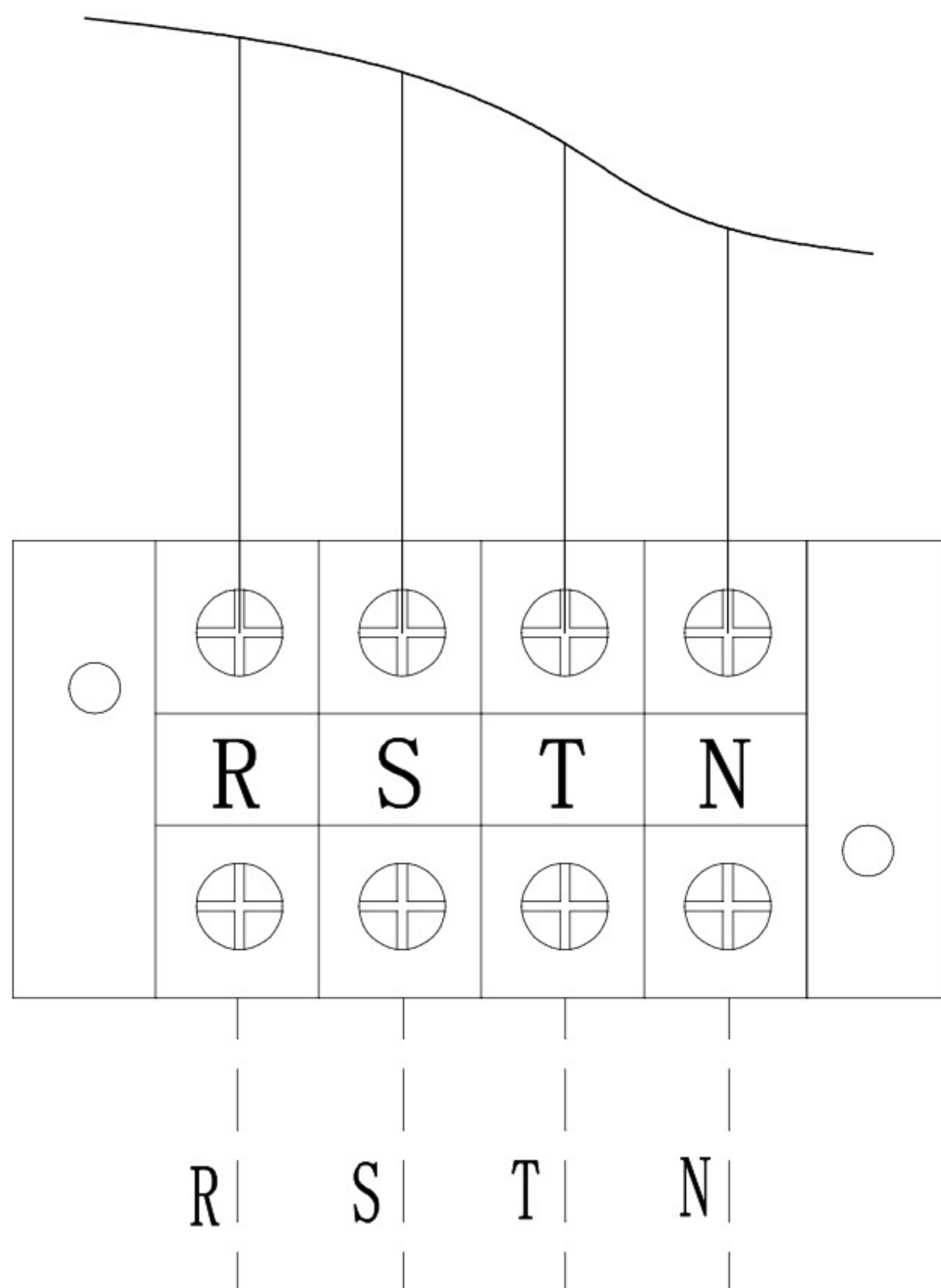

Power supply specification:
380~415V/50Hz

Neutral, live wire copper
wire: wire diameter is not
less than 6mm²

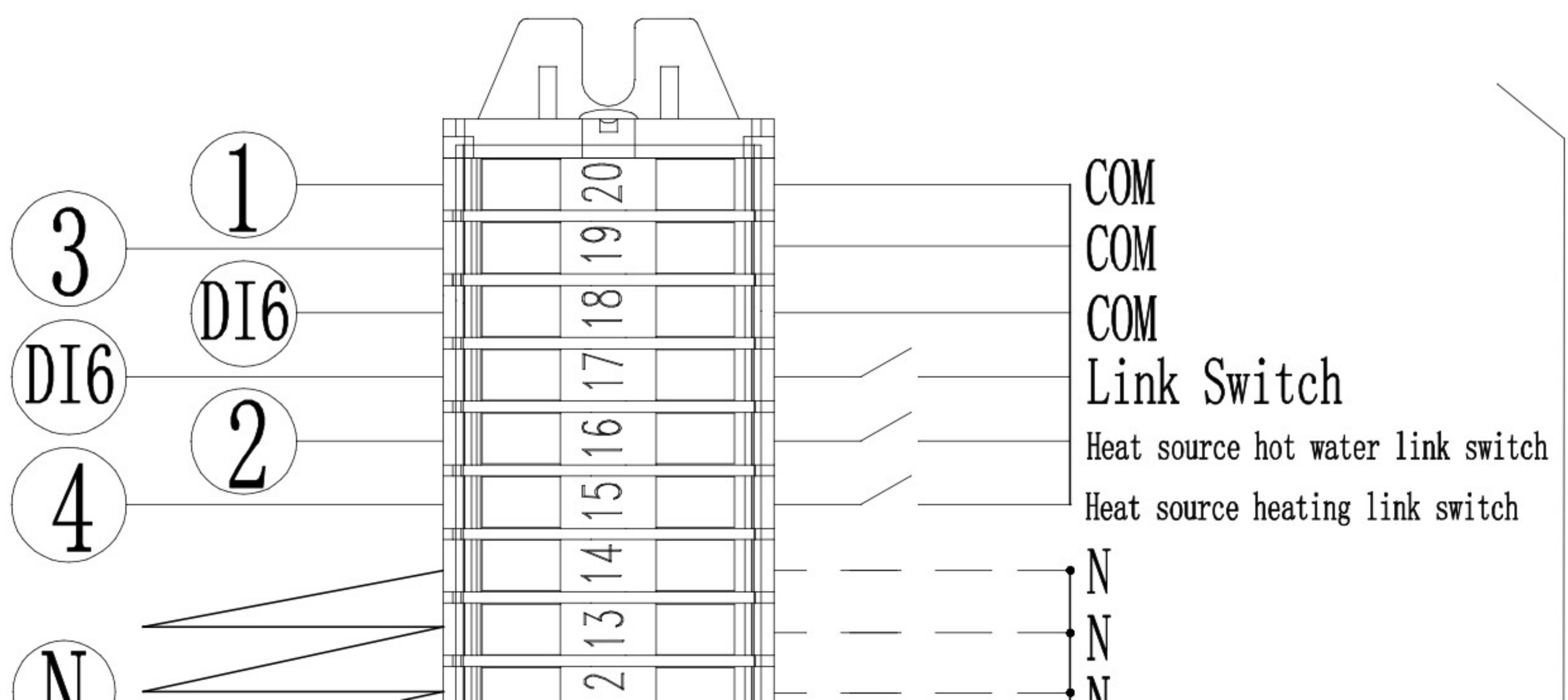

Commissioning and Maintenance

1. Precautions Before Commissioning

- 1.1 Is the machine adequately installed?
- 1.2 Is the wiring and pipe correct?
- 1.3 Whether the water pipelines are empty or not?

-
- 1.4 Whether the heat insulation has been perfected?
 - 1.5 Is the ground wire connected reliably?
 - 1.6 Whether the power supply voltage matches the rated voltage of the machine?
 - 1.7 Is there any obstacle in the air inlet and outlet of the machine?
 - 1.8 Is the safety valve installed correctly?
 - 1.9 Whether the leakage protector can operate effectively?
 - 1.10 The system water pressure is not less than 0.15 MPa, and the maximum pressure cannot exceed 0.5 MPa;
 - 1.11 In winter, the machine needs to be energized at least 24 hours before the operation, as the compressor needs to be preheated.

2. Commissioning

Use the controller to control the machine and check the following items according to the instruction manual: (If there is any fault, please find out the faults and reasons described in the manual and eliminate them)

- 2.1 Is the controller regular?
- 2.2 Is the function key of the controller regular?
- 2.3 Is the drainage normal?
- 2.4 Test whether the heating mode and cooling mode are working correctly;
- 2.5 Is the outlet water temperature average?
- 2.6 Whether there is vibration and abnormal sound during operation?
- 2.7 Does the generated wind, noise, and condensate affect neighbours?
- 2.8 Is there a refrigerant leakage?

3. Operation and Debugging

- 3.1 About 3mins of protection
Due to the self-protection of the compressor, the machine cannot be restarted again within 3 mins.
- 3.2 Feature of heating operation
If the ambient temperature is too high during operation, the outdoor motor may run low or stop.
- 3.3 In the case of heating operation, when the unit has frost formation, the defrosting procedure (about 2-8 minutes) is automatically performed to improve the heating effect. The outdoor motor stops running during the “defrost” operation.
- 3.4 Power Outage
If there is a power outage during operation, the machine will stop running. Before the power outage, the controller automatically memories the ON/OFF status of the device. After re-powering, the controller will send an ON/OFF signal to the device according to the state of memory before the power outage to ensure that the device recovers from the previous status from abnormal power failure.
- 3.5 Heating Capacity
Because the heat pump absorbs heat from the outside, the heating capacity will be reduced

once the outdoor temperature is lowered.

3.6 Electric Leakage Protector

After the unit has been running for some time (usually one month), the leakage protector needs to press the test button under the closed energized state to check whether the performance of the leakage protector is regular and reliable (the leakage protector should be disconnected once every time the test button is pressed). If the accident is not found, the test can be sent once. If it is not working, the cause should be found, and if necessary, the action characteristic test should be carried out. After checking, it is confirmed that the leakage protector itself has failed. It should be replaced or repaired in time.

3.7 Working Temperature Range

To use the machine correctly, please operate under the following conditions, outdoor temperature: - 30 °C ~ 45 °C for heating mode, 16 °C ~ 45 °C for cooling mode.

3.8 Antifreeze in the winter

When the ambient temperature is below 0 °C, it is strictly forbidden to cut off the power. If there is an unexpected power failure under this condition, please drain the water from the heat.

4. Maintenance

1. Please check whether the grounding wire is connected reliably before use. If there is any abnormality, please replace it in time.
2. Please check the air inlet and outlet of the outdoor unit regularly for blockage.
3. Professionals must clean the outdoor unit heat exchanger, casing, and water circulation piping. It is recommended to clean the filter of the waterside filter regularly (cleaning is usually done once a year, depending on the actual situation).
4. Regularly check that the safety valve is working correctly, and ensure that the drain can be drained normally by manually turning the red knob (usually once every three months, depending on the actual situation).
5. Regularly (usually once a year, but depending on the actual situation) check whether the water pipe joint and the refrigerant connection pipe are leaking or leaking refrigerant (there are oil leakage marks). If there is any leak, please contact the seller.
6. The machine can only be serviced by a professional. The device must be cut off before contacting the wiring part.
7. Once the machine will not be used for a long time, please cut off the power, drain the water in the pipeline, and close each valve.

Trouble Analysis

| Error code | Fault Description | Failure Causes |
|------------|---------------------------------|---|
| E01 | Wrong-Phase Protection | Power supply phase sequence error |
| E02 | Power Supply Lack Of Phase | The power supply is out of phase |
| E03 | Outside Water Flow Switch Fault | 1. Circulating pump failed, or water system blocked |

| | | |
|-----|---|--|
| | | <ul style="list-style-type: none"> 2. Water flow switch failed, or opposite installed direction 3. The lift of the circulating pump is not enough 4. Circulating pump has opposite installed direction |
| E04 | Abnormal Communication Between The Main Control Board And Remote Module | Check the communication connection |
| E05 | High-Pressure Switch One Fault | <ul style="list-style-type: none"> 1. High-voltage switch failed 2. Excessive refrigerant 3. Fan doesn't work typically, or water circulated abnormally 4. Air or other objects mixed into the refrigeration system 5. Too much scale in the water heat exchanger |
| E06 | Low-Pressure Switch One Fault | <ul style="list-style-type: none"> 1. Low-voltage switch fault 2. Lack of refrigerant 3. Fan doesn't work normally 4. Block exists in refrigeration system |
| E07 | High-Pressure Switch Two Fault | Same as E05 |
| E08 | Low-Pressure Switch Two Fault | Same as E06 |
| E10 | Indoor Side Water Flow Failure | Same as E03 |
| E11 | Limited Time Protection | Enter the power-on password |
| E12 | Exhaust Gas Temperature One Too High Fault | Lack of refrigerant in the fluorine circuit system or sensor damage |
| E13 | Exhaust Gas Temperature Two Too High Fault | Lack of refrigerant in the fluorine circuit system or sensor damage |
| E14 | Hot Water Tank Temperature Failure | Damaged motherboard or sensor |
| E15 | Water Inlet Temperature Sensor Failure | Damaged motherboard or sensor |
| E16 | Coil Sensor One Failure | Damaged motherboard or sensor |
| E17 | Coil Sensor Two Failure | Damaged motherboard or sensor |
| E18 | Exhaust Gas Sensor One Fault | Damaged motherboard or sensor |
| E19 | Exhaust Gas Sensor Two Fault | Damaged motherboard or sensor |
| E20 | Indoor Temperature Sensor Failure | Damaged motherboard or sensor |
| E21 | Environmental Sensor Failure | Damaged motherboard or sensor |
| E22 | User Return Water Sensor Failure | Damaged motherboard or sensor |
| E23 | Cooling Subcooling Protection | Normal anti-freeze protection |
| E24 | Board Change Out Temperature Fault | Damaged motherboard or sensor |
| E25 | Water Level Switch Malfunction | Damage to the mainboard or water level sensor |
| E26 | Anti-Freeze Sensor Malfunction | Damaged motherboard or sensor |
| E27 | Water Outlet Sensor Failure | Damaged motherboard or sensor |
| E28 | Reservation | Reservation |
| E29 | Return Air Sensor One Fault | Damage to the mainboard or water level sensor |
| E30 | Return Air Sensor Two Fault | Damage to the mainboard or water level sensor |
| E31 | Water Pressure Switch Failure | Water pressure switch failure |

| | | |
|-----|--|--|
| E32 | Excessive Water Temperature Protection | Insufficient water flow or a damaged sensor |
| E33 | High Pressure One Sensor Fault | Damaged motherboard or sensor |
| E34 | Low Pressure One Sensor Fault | Damaged motherboard or sensor |
| E35 | Reservation | Reservation |
| E36 | Reservation | Reservation |
| E37 | The Excessive Temperature Difference Between Inlet And Outlet Water Protection | Insufficient water flow |
| E38 | DC Fan One Failure | Fan drive board or motor damage |
| E39 | DC Fan Two Failure | Fan drive board or motor damage |
| E40 | DC Fan Three Failure | Fan drive board or motor damage |
| E41 | DC Fan Four Failure | Fan drive board or motor damage |
| E42 | Cooling Coil Sensor One Fault | Damaged motherboard or sensor |
| E43 | Cooling Coil Sensor Two Fault | Damaged motherboard or sensor |
| E44 | Low Ambient Temperature Protection | It is a standard protection |
| E45 | High Pressure Two Sensor Failure | Damaged motherboard or sensor |
| E46 | Low Pressure Two Sensor Failure | Damaged motherboard or sensor |
| E47 | Economizer Inlet Sensor One Failure | Damaged motherboard or sensor |
| E48 | Economizer Inlet Sensor Two Failure | Damaged motherboard or sensor |
| E49 | Economizer Outlet Sensor One Failure | Damaged motherboard or sensor |
| E50 | Economizer Outlet Sensor Two Failure | Damaged motherboard or sensor |
| E51 | High Pressure One Overvoltage Protection | Same as E05 |
| E52 | Low-Pressure One Undervoltage Protection | Same as E06 |
| E53 | High-Pressure Two Overvoltage Protection | Same as E05 |
| E54 | High Pressure Two Undervoltage Protection | Same as E06 |
| E55 | Expansion Board Communication Exception | Poor or broken signal cable contact |
| E80 | Power Supply Error | Single-phase power unit detects a three-phase electrical signal. |
| E88 | Inverter Module 1 Protection | Compressor or compressor driver board damaged |
| E89 | Inverter Module 2 Protection | Compressor or compressor driver board damaged |
| E94 | Water Pump Feedback Failure | Damaged DC pump or poor signal line contact |
| E96 | Abnormal Communication between Compressor One Driver and Main Control Board | Poor or broken signal cable contact |
| E97 | Abnormal Communication between Compressor Two Driver and Main Control Board | Poor or broken signal cable contact |
| E98 | Abnormal Communication between Fan Motor One Driver and Main Control Board | Poor or broken signal cable contact |

| | | |
|-----|--|-------------------------------------|
| E99 | Abnormal Communication between Fan Motor Two Driver and Main Control Board | Poor or broken signal cable contact |
|-----|--|-------------------------------------|

Fault Protection Instructions

1. The machine stops running when a fault is detected;
2. When the fault is removed, the compressor is shut down for three minutes before the machine can be put back into operation;
3. If there are three consecutive low-pressure faults, high-pressure fault, over the current spot, and gas exhaust temperature too high within 30 minutes, the machine will immediately stop running. After the fault is rectified, turn the power on again, start the controller, and the device can be put into operation.
4. If the machine stops running due to the inlet water temperature sensor or the coil temperature sensor fault due to compressor protection, the device will have to be back into operation 3mins later after the spot is removed. If the ambient temperature sensor fails, the machine continues to run.

Maintenance Instructions

1. The machine is equipped with an inspection needle valve on the suction and exhaust pipes. The maintenance personnel can connect the pressure gauge to check the high and low-pressure conditions of the system.
2. If the machine is filled with refrigerant under operating conditions, the refrigerant must be served at the needle valve of the low-pressure side. Suppose the refrigerant is added to the suction side. In that case, the refrigerant opening must be small so that the refrigerant in the refrigerant bottle slowly enters the system to prevent liquid slamming.
3. Refrigerant leakage detection
Check if there is any leakage at the joints with soapy water or a refrigerant leak detector. When a refrigerant leak occurs, the leak point must be found, and the leak point must be repaired. Please ensure no refrigerant or other pressures are left in the system when improving the leak point. Otherwise, it will easily cause copper pipe explosive during welding. The tube is blasted by refrigerant pressure or additional pressure, causing accidental injury to the operator.
Note: When refrigerant leakage occurs in a small space, open all vents or forced ventilation to discharge the refrigerant before performing related operations to prevent people from suffocating accidents.

Specification

| Model: | | One | One+ | | PRO | |
|--------------|-------------|--------------|--------------|--|--------------|--|
| Power Supply | V/Ph/ Hz | 220~240/1/50 | 380~415/3/50 | | 380~415/3/50 | |

| | | | | | | | |
|---|------------------|------|--------------------------|-----------|-----------|-----------|-----------|
| Nominal Heating (Max) (A7/6°C,W30/35°C) | Heating Capacity | kW | 3.0~9.1 | 5.5~15.1 | | 7.5~22.1 | 7.5~22.1 |
| | Power Input | kW | 0.65~2.29 | 1.08~3.9 | | 1.5~6.8 | 1.5~6.8 |
| | Current Input | A | 2.8~9.1 | 4.5~17.0 | | 6.9~31.1 | 2.7~12.3 |
| Nominal Heating (Max) (A7/6°C,W47/55°C) | Heating Capacity | kW | 2.85~8.50 | 5.0~13 | 5.0~13 | 7.0~18.9 | 7.0~18.9 |
| | Power Input | kW | 0.95~2.85 | 1.75~4.96 | 1.75~4.96 | 2.15~7.35 | 2.15~7.35 |
| | Current Input | A | 2.9~9.2 | 4.6~17.1 | 1.9~7.0 | 7.0~31.3 | 2.8~12.4 |
| Nominal Cooling (Max) (A35/24°C,W12/7°C) | Cooling Capacity | kW | 1.25~5.8 | 3.65~10.2 | 3.65~10.2 | 4.5~17.7 | 4.5~17.7 |
| | Power Input | kW | 0.65~2.35 | 1.12~4.16 | 1.12~4.16 | 1.80~7.30 | 1.80~7.30 |
| | Current Input | A | 2.9~10.4 | 4.8~17.3 | 2.0~7.8 | 7.8~32.4 | 3.3~12.9 |
| ERP Level (Outlet water temp. at 35°C) | | / | A+++ | A+++ | A+++ | A+++ | A+++ |
| MAX. input power | | kW | 3.00 | 5.50 | 5.50 | 7.50 | 9.00 |
| MAX. input current | | A | 13.50 | 24.50 | 10.50 | 35.00 | 16.00 |
| Refrigerant / Weight | | / | R290 | R290 | R290 | R290 | R290 |
| Rated water flow | | m³/h | 1.00 | 1.80 | 1.80 | 3.00 | 3.00 |
| Fan quantity | | / | 1 | 1 | 1 | 2 | 2 |
| Fan motor type | | / | DC inverter | | | | |
| Compressor | | / | DC inverter | | | | |
| Circulating pump | | / | Inverter type / Built-in | | | | |

| | | | | | | |
|---|-------|--------------|---------------|---------------|----------------|----------------|
| IP Class | / | IPX4 | | | | |
| Sound pressure at 1m distance | dB(A) | 42 | 44 | 44 | 48 | 48 |
| Max outlet water temperature | °C | 75 | 75 | 75 | 75 | 75 |
| Water piping connections | / | DN 25 (1") | DN 25 (1") | DN 25 (1") | DN 32 (1-1/4") | DN 32 (1-1/4") |
| Water Pressure drop(max) | kPa | 20 | 25 | 25 | 60 | 60 |
| Operating temperature range (Heating mode) | °C | -30~45 | | | | |
| Operating temperature range (Cooing mode) | °C | 16~45 | | | | |
| Unpacked Dimensions (LxDxH) | mm | 1187*418*805 | 1287*448*904 | 1287*448*904 | 1187*488*1455 | 1187*488*1455 |
| Packed Dimensions (LxDxH) | mm | 1217*463*920 | 1317*493*1020 | 1317*493*1020 | 1217*538*1570 | 1217*538*1570 |
| UnPacked Weight | kg | 90 | 110 | 110 | 145 | 145 |
| Packed Weight | kg | 115 | 125 | 125 | 160 | 160 |

Note : We reserves the right to discontinue, or change at any time, specifications or designs without notices and without incurring obligations

After-sale Service

Relevant state regulations carry out the after-sales service of our products. Within the scope of the warranty period, If the machine is not working correctly under reasonable use, please contact the seller.

The user must designate a person to manage and use the unit reasonably and correctly by our company's "Instructions for Use." Accidents caused by improper use are not covered by our company's warranty, and the repair costs and repair costs beyond the warranty period must be taken care of by the user.

1. After-sale Service

The seller or the specified professional installer should perform maintenance and repair. Improper maintenance or repair may result in water leakage, electric shock, and fire.

- 1.1 Please contact the seller when the machine has to be moved or reinstalled. Improper installation may result in water leakage, electric shock, and fire.
- 1.2 When you need after-sales service, please contact the seller and provide the following details:
 - 1) Model No.
 - 2) Serial Number and Manufacture Date
 - 3) Detailed Description of the fault
 - 4) Your name, Address, and Contact Number





If the warranty period is expired or the malfunction is caused by improper use, the company will charge a certain service fee if you need after-sales service.

2. Maintenance









After a period of use, the heat pump's performance will be reduced due to the accumulation of dust inside the machine, so maintenance is required.

- 1) You should regularly check the water supply system to avoid the air entering the water system and the occurrence of low water flow, which would reduce the performance and reliability of the heat pump.
- 2) Clean your filtration system regularly to avoid unit damage because of a dirty or clogged filter.
- 3) Discharge the water from the bottom of the water pump if the heat pump will stop running for a long time (especially in winter)
- 4) At any other moment, check the water flow to confirm enough water before the unit starts to run again.
- 5) After the unit is conditioned in winter, it is preferred to cover the team with a unique winter heat pump cover.

Appendix for Controller

| Icon | Status | Functions or meanings | Remark |
|---|-------------------|--|-----------------------|
|  | Lights out | Currently in off or non-hot water mode | Display on/off status |
|  | Constant flashing | Currently in hot water mode on | Display on/off status |
|  | Lights out | Currently in off or non-heating mode | Display on/off status |
|  | Constant flashing | Currently in heating mode | Display on/off status |

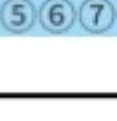
| | | | |
|---|-------------------|--|-----------------------|
|  | Lights out | Currently in off or non-cooling mode | Display on/off status |
|  | Constant flashing | Currently in cooling mode | Display on/off status |
|  | Lights out | Currently in off or non-floor heating mode | Display on/off status |
|  | Constant flashing | Currently in floor heating mode | Display on/off status |
|  | Constant flashing | Silent mode / Night mode | Power on display |
|  | Constant flashing | Powerful mode | Power on display |
|  | Constant flashing | Intelligent Mode | Power on display |
|  | Constant flashing | Electric auxiliary heating work (AC, hot water electric heating) | Power on display |
|  | 1s flashing | Electric auxiliary heat quick heat mode is enabled | Power on display |
|  | 2s flashing | Electric auxiliary heat sterilization mode is enabled | Power on display |
|  | Flashing | WiFi Allocation | |
|  | Constant flashing | WiFi connection successful | |
| IN | Constant flashing | Represents water intake | |
| OUT | Constant flashing | Represents water discharge | |
| RT | Constant flashing | Represents actual temperature/room temperature | |
| SET | Constant flashing | Representative Settings | |
| °C | Constant flashing | Display Celsius temperature | |
| °F | Constant flashing | Display Fahrenheit temperature | |
| % | Constant flashing | Show percentage | |
| 88.8 | Constant flashing | Display of actual values, set values and fault codes | |
|  | Flashing | Circulating water pump: freeze-proof operation | |
|  | Constant flashing | Circulating water pump: normal operation | |
|  | Constant flashing | Hydration valve open | |
|  | Constant flashing | Return water valve open | |
|  | 1Hz flashing | Activate timed water return feature | |
|  | 2Hz flashing | Activate manual water return function | |
|  | Constant flashing | High, medium and low water levels are displayed | |
|  | Constant flashing | The water supply valve | |
|  | Constant flashing | Photovoltaic mode/solar heating | |
|  | 1 Hz flashing | Start PV timing | |
|  | Flashing | Currently in shutdown and refrigerant recovery state | |
|  | Constant flashing | Currently on and defrosting | |
|  | Constant flashing | Enter maintenance status | |
|  | Constant flashing | Alarm is currently occurring | |
|  | Constant flashing | Current button is locked | |

| | | | |
|---|----------------------|---|--|
|  | Constant flashing | Compressor operation | |
|  | Constant flashing | High wind operation of the fan | |
|  | Constant flashing | Fan low wind operation | |
|  | 1 second flash | Ventilation mode: high speed wind | |
|  | 2 second flash | Ventilation mode: low speed wind | |
|  | Constant flashing | Online networking | |
|  | Constant flashing | Display the current network unit number | |
| 88.8 | Display | Display real-time time | |
|  | Always bright | Enable timed work mode | |
| ON | Display | Currently in the power-on timer period | |
| ON | Flashing | Current set working period start time | |
| OFF | Display | Currently in power-on timed non-working hours | |
| OFF | Flashing | Current set working period end time | |
| 123 | Flashing / Light out | Timed working hours 1, 2, 3, always on when set or when the clock enters this period, off in the rest of the case | |
|  | Display | Show current week 1, 2, 3, 4, 5, 6, 7 | |

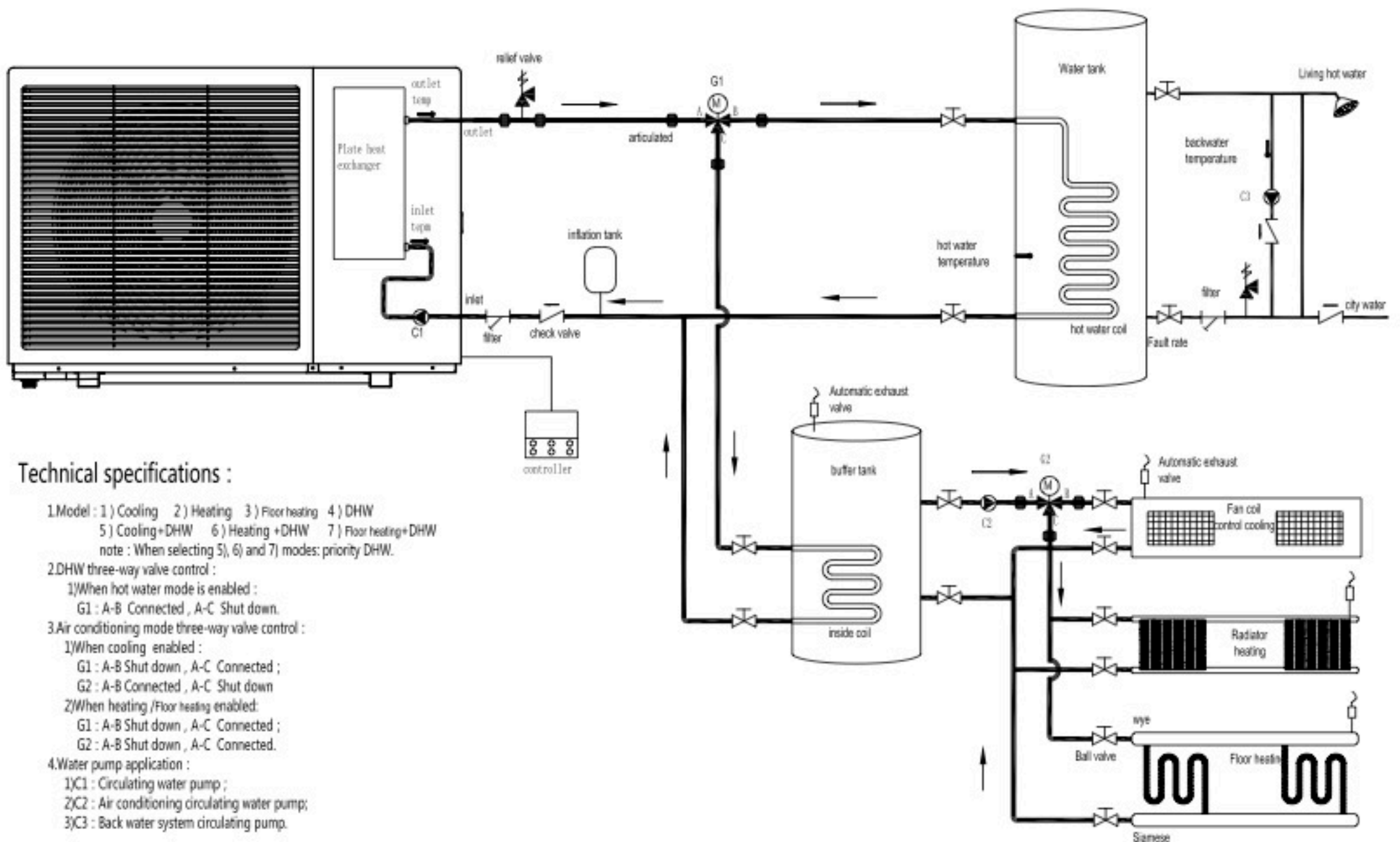

Technical specifications :

1. Model : 1) Cooling 2) Heating 3) Floor heating 4) DHW
 5) Cooling+DHW 6) Heating +DHW 7) Floor heating+DHW
 note : When selecting 5), 6) and 7) modes: priority DHW.
2. DHW three-way valve control :
 1) When hot water mode is enabled :
 G1 : A-B Connected , A-C Shut down.
3. Air conditioning mode three-way valve control :
 1) When cooling enabled :
 G1 : A-B Shut down , A-C Connected ;
 G2 : A-B Connected , A-C Shut down
 2) When heating /Floor heating enabled:
 G1 : A-B Shut down , A-C Connected ;
 G2 : A-B Shut down , A-C Connected.
4. Water pump application :
 1) C1 : Circulating water pump ;
 2) C2 : Air conditioning circulating water pump;
 3) C3 : Back water system circulating pump.

Leistungsdiagramm

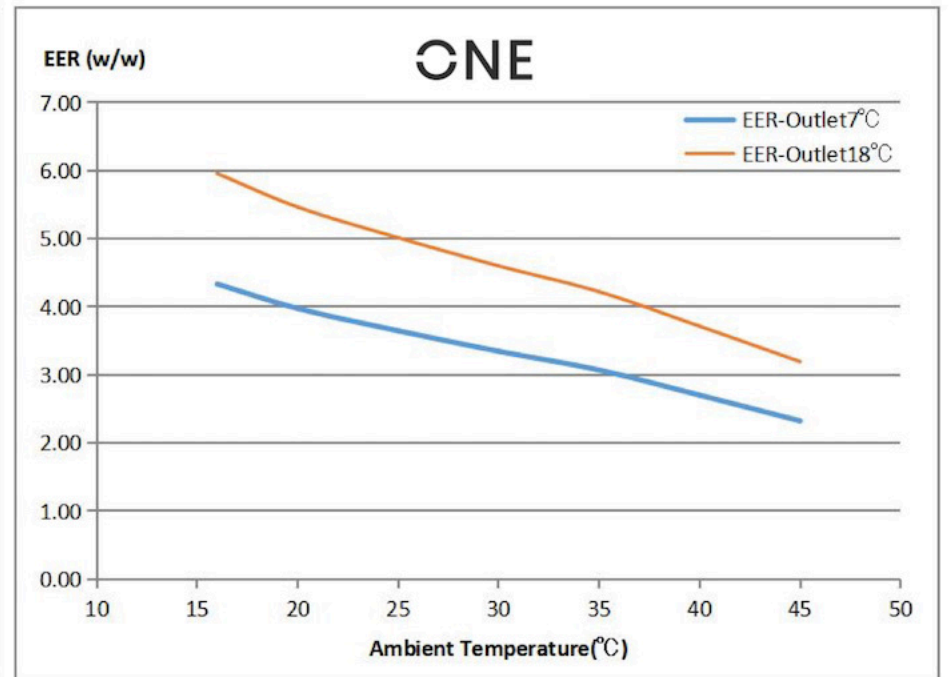
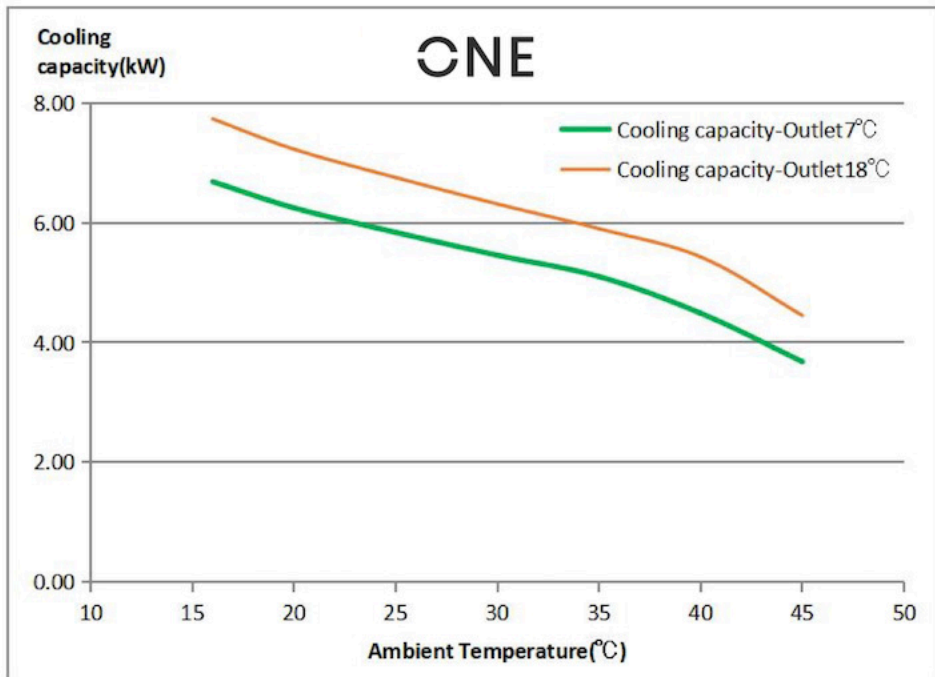
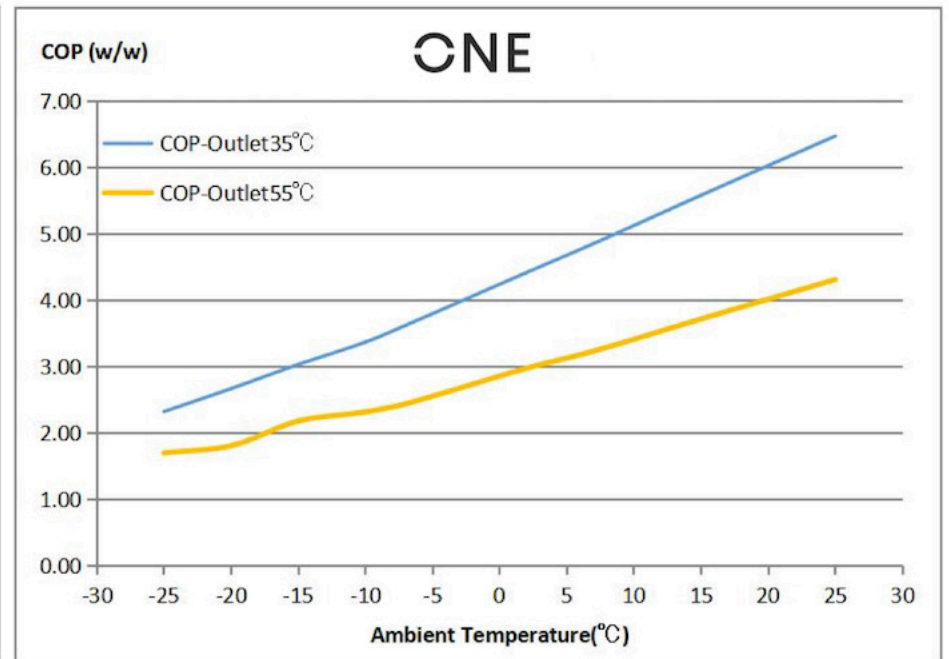
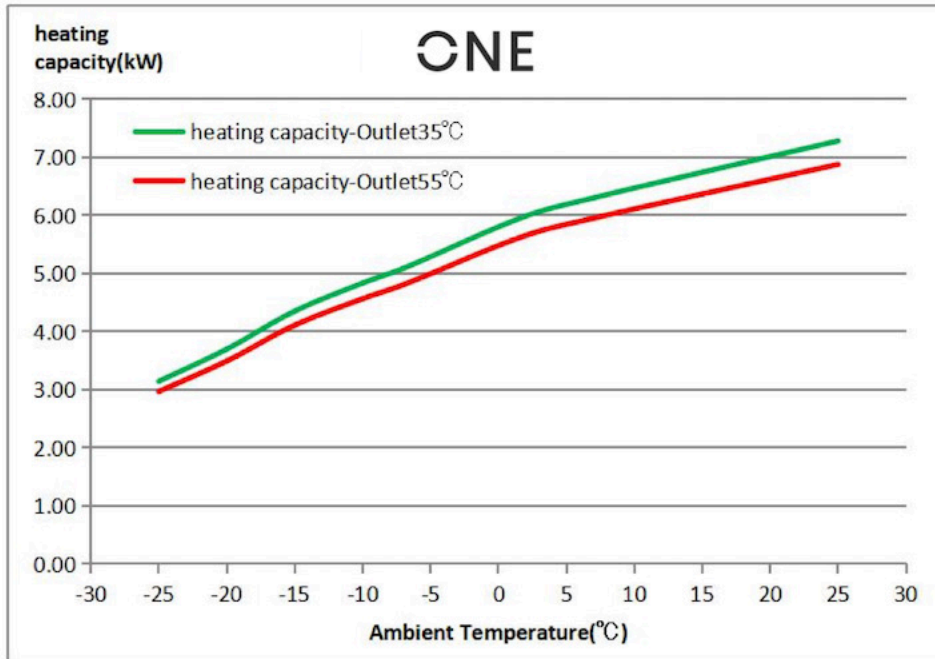

Leistungsdiagramm ONE+

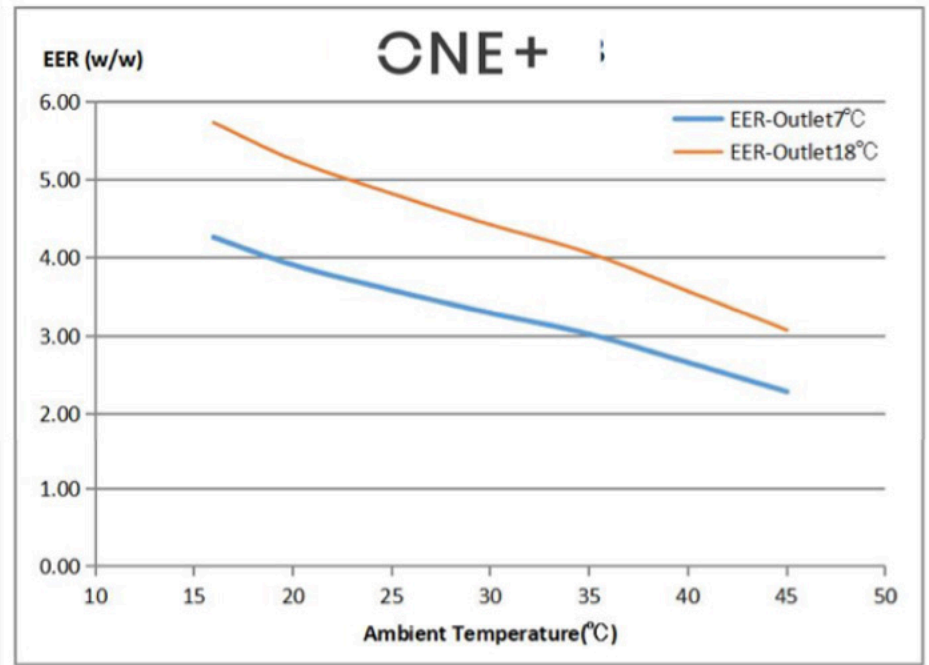
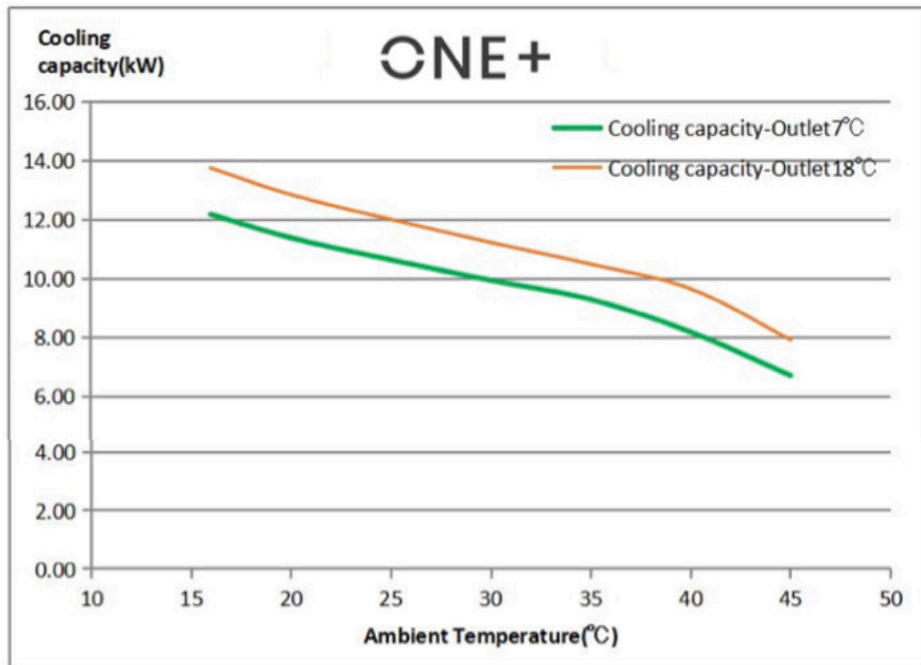
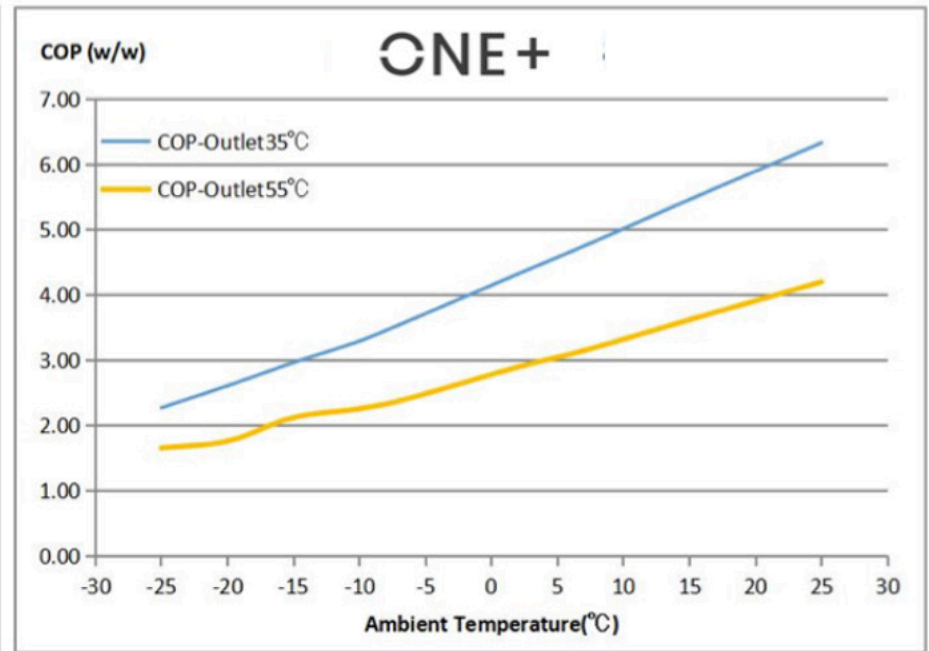
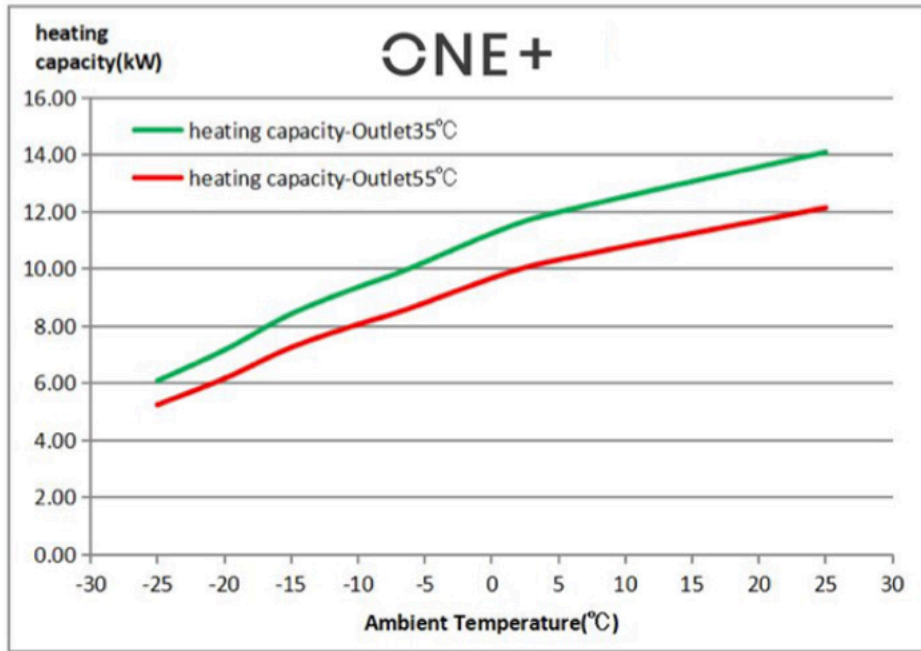

Leistungsdiagramm PRO

